

# LX-80-8 Level Sensor

RADAR LEVEL SENSOR FOR WATER AND SNOW LEVEL MONITORING

## Highlights

- Contactless measurement of distance from the sensor to the surface
- Works on water, ground, most fluids and solids
- Ultra-precise 80 GHz radar technology
- Measurement accuracy +/-3 mm
- Measurement quality not affected by changes in air temperature or density
- Simple installation
- IP-68 rated enclosure
- Supports variety of communication interfaces
- Configurable range of interest
- Easy mounting
- Compatible with Geolux SmartObserver datalogger and Geolux HydroView cloud-based software for real-time remote monitoring
- Low power consumption

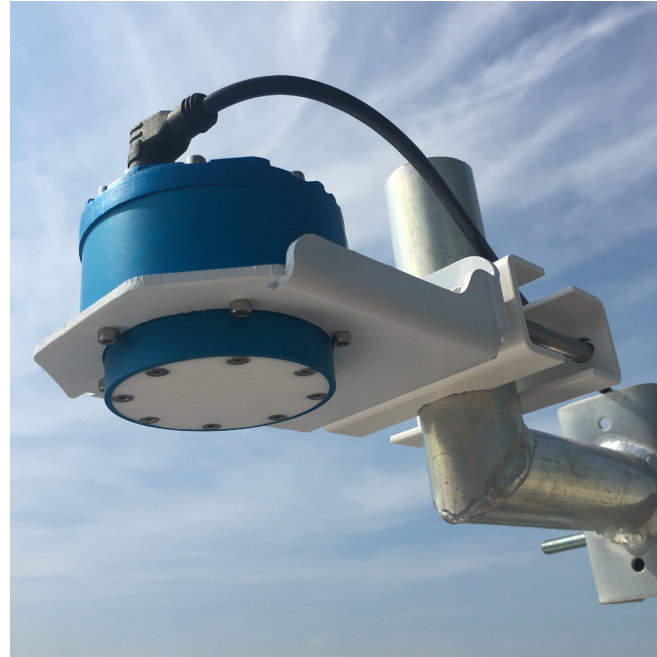

## Product Description

Geolux LX-80-8 is an advanced level sensor that measures the distance from the sensor to the surface. LX-80-8 uses advanced 80 GHz radar technology to provide accurate and stable measurements. Using contactless technology for measurement of level of fluids and solids provides many advantages over traditional methods due to simple installation, low power consumption and minimal to none maintenance. Geolux LX-80-8 can be used for hydrological measurements of open-channels, for snow level measurement, for industrial measurements of fluid levels in tanks and for measurements of level for various solids in industrial and environmental applications.

Sensor can be also used for measurement of distances of actuators or moving and static machinery parts for control or monitoring purpose in industrial environment.

LX-80-8 was designed for easy integration in existing environmental and industrial monitoring systems. Low power consumption, multiple supported communication interfaces, and compatibility with Geolux datalogger and real-time remote monitoring software all allow our customers to quickly and effortlessly integrate LX-80-8 into new or existing applications.

When compared to ultrasonic sensors for level measurement, radar technology provides advantage in precision, as the changes in air temperature which affect the quality of ultrasound measurements do not affect radar measurements. Software radio-defined (SDR) design of the sensor allows easy upgrades, integration of advanced logic and detection possibilities and simple customization for each specific measurement problem and process.

## Detailed Specifications

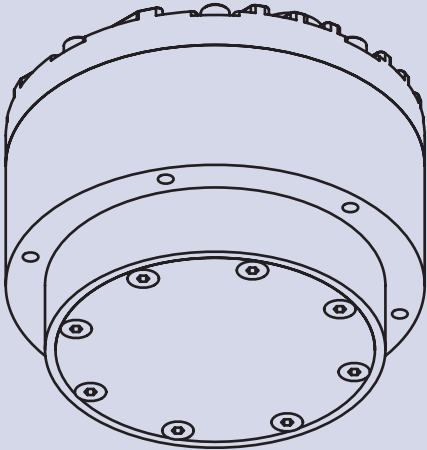
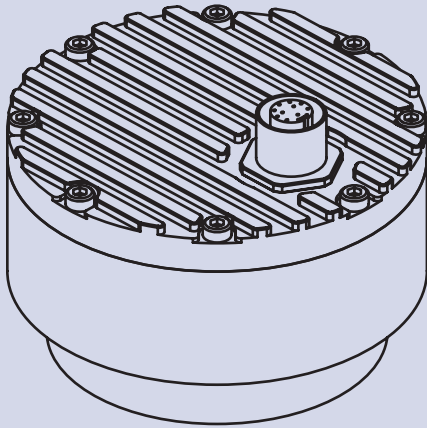

<b>Radar Type</b>	W-band 77-81 GHz FMCW radar
<b>Beam Angle</b>	12° both axes
<b>Detection Distance</b>	8 m
<b>Blind Zone</b>	0,2 m
<b>Resolution</b>	0,5 mm
<b>Accuracy</b>	+/-3 mm
<b>Sampling Frequency</b>	1 sps / 10 sps optional
<b>IP Rating</b>	IP68
<b>Serial Interface</b>	1x serial RS-485 half-duplex 1x serial RS-232 (two wire interface)
<b>Serial Baud Rate</b>	1200 bps to 115200 bps
<b>Serial Protocols</b>	Modbus, GLX-NMEA
<b>CAN Interface</b>	Up to 1Mbps CAN2.0
<b>Analog Interface</b>	4-20 mA
<b>Other Interfaces</b>	SDI-12
<b>Connector</b>	M12 circular 12-pin
<b>Power Input</b>	9 to 27 VDC
<b>Power Consumption</b>	< 2,2 W (typical 1,8 W)
<b>Maximal Current</b>	< 400 mA
<b>Temperature Range</b>	-40°C to +85°C (without heating or coolers)
<b>Enclosure Dimensions</b>	φ 65 mm x H 55 mm

FCC & CE **APPROVED**

MADE IN **EU**

Geolux is a company based in the European Union that develops and manufactures radar sensors for use in traffic, security and hydrology applications.

**For more information, contact us:**

Phone: +385 1 6701 241  
E-mail: [geolux@geolux.hr](mailto:geolux@geolux.hr)



[www.geolux-radars.com](http://www.geolux-radars.com)