

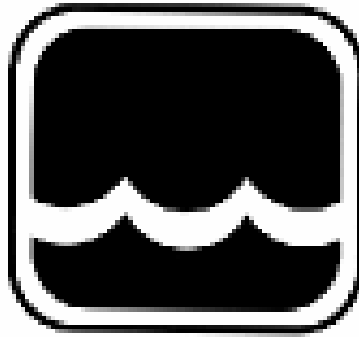

Global Water
800-876-1172 • globalw.com

FL16 Flow Logger

Covers USB (FL16U) and Serial (FL16S) Versions



Global Water

Instrumentation, Inc.

11390 Amalgam Way
Gold River, CA 95670
T: 800-876-1172

Int'l: (916) 638-3429, F: (916) 638-3270
globalw@globalw.com

06/21/07
01-497



Global Water

800-876-1172 • globalw.com

Congratulations on your purchase of a Global FL16 Flow Logger. This instrument has been quality tested and approved for providing accurate and reliable measurements. We are confident that you will find the logger to be a valuable asset to your applications. Should you require assistance, our technical staff will be happy to help.

Table of Contents

I.	Checklist	□	□	□	□	□	3
II.	Inspection		□	□	□	□	3
III.	Warranty	□	□	□	□	□	3
IV.	FL16 Specifications	□	□	□	□		4
V.	Introduction	□	□	□	□	□	6
VI.	Software Compatibility		□	□	□		7
VII.	System Requirements		□	□	□		7
VIII.	Software Installation	□	□	□	□		8
IX.	Direct Connection	□	□	□	□		11
X.	Modem Connection	□	□	□	□		12
XI.	Main Screen	□	□	□	□	□	15
XII.	On-Line Help Files	□	□	□	□	□	19
XIII.	Get History	□	□	□	□	□	20
XIV.	Setup Menus	□	□	□	□	□	21
XV.	General Setup	□	□	□	□	□	22
XVI.	Analog Setup	□	□	□	□	□	25
XVII.	Flow Calculation Setup		□	□	□		27
XVIII.	Programming	□	□	□	□	□	32
XIX.	Calculations	□	□	□	□	□	33
XX.	Modem Cable Diagram		□	□	□		34
XXI.	Maintenance	□	□	□	□	□	35
XXII.	Troubleshooting	□	□	□	□	□	35
XXIII.	Customer Support	□	□	□	□		36



Global Water
800-876-1172 • globalw.com

I. Checklist:

- a. FL16S (Serial) or FL16U (USB) Data Logger
- b. FL16 Sewer Flow Level Sensor
- c. FL16 Flow Logger Manual
- d. FL16S comes with a RS-232 Serial Cable
- e. FL16U comes with a USB Cable, Type A to B
- f. Global Logger Interface Software on CDROM

II. Inspection:

- a. Your Data Logger was carefully inspected and certified by our Quality Assurance Team before shipping. If any damage has occurred during shipping; please notify Global Water Instrumentation, Inc. and file a claim with the carrier involved.

III. Warranty:

- a. Global Water Instrumentation, Inc. warrants that its products are free from defects in material and workmanship under normal use and service for a period of one year from date of shipment from factory. Global Water's obligations under this warranty are limited to, at Global Water's option: (I) replace or (II) repair; any products determined to be defective. In no case shall Global Water's liability exceed the products original purchase price. This warranty does not apply to any equipment that has been repaired or altered, except by Global Water Instrumentation, Inc., or which has been subject to misuse, negligence or accident. It is expressly agreed that this warranty will be in lieu of all warranties of fitness and in lieu of the warranty of merchantability.
- b. The warranty begins on the date of your invoice.



Global Water
800-876-1172 • globalw.com

IV. FL16 Specifications:

Logger:

Power Supply:	Two 9VDC Lithium batteries standard 8 VDC Min. to 24.0 VDC Absolute Maximum Standby Current: 65uA Typical Logging Current: 5mA Typical + sensor current
Operating Temperature	Industrial, -40°C to +85°C (Battery may not apply)
Analog Sensor Inputs:	4-20mA Resolution: 12-Bit, 4096 Steps Level, temperature and battery voltage monitor Sensor Warm-up Time: Programmable, 0-15 Seconds
Sample Modes:	Fixed Interval: Programmable from 1 Sec. to >1 Year High Speed: 10 Samples per second Logarithmic Sample Rate (Approximation) Exception (Log only on deviation from previous reading)
Storage Capacity:	81,759 Recordings of level, temp, battery voltage plus date/time stamp
Communication Ports:	FL16S: RS-232 4-pin circular connector FL16U: USB Type B Selectable Baud Rates: 9600, 19200, 28800, 38400, 57600, 115200
Housing:	1 7/8 diameter x 11 1/2 long, Stainless Steel and PVC
Weight:	450g (16oz), Logger only with batteries



Global Water
800-876-1172 • globalw.com

Level Sensor:

Sensor Element: Silicone Diaphragm, Wet/Wet Transducer
Range: Level: 0-3 feet
Temperature: 32°-122°F (0°-50°C)
Linearity and Hysteresis: $\pm 0.1\%$ FS
Accuracy: Level: $\pm 0.1\%$ FS at constant temperature
 $\pm 0.2\%$ over 32° to 70°F range
Temperature: Smaller of 0.5°F or $\pm 1\%$ of reading
Overpressure: 2 x full scale
Burst Pressure: 10 x full scale
Resolution: Infinite (Analog)
Outputs: 4-20mA ± 1 mA at full scale
Optional Temperature: 0-10mA ± 1 mA FS
Supply Voltage: 10-36VDC
Current Draw: Sum of sensor outputs.
Warm Up Time: 10mS Min, 3 sec. recommended
Operating Temperature: 0° (Not Frozen) to +185°F
Compensated Range: 32° to 70°F submerged, automatic barometric compensation

Sensor Housing:

Material: 316 SS
Size: 9" long x 1.0" diameter
Weight: 250g (9oz)

Cable:

Conductors: 4 each 22 AWG
Jacket Material: 87A shore hardness Polyurethane
Optional jacket: Fluorinated Ethylene Propylene (FEP) Teflon
Cable O.D.: 7.8mm (0.307")
Vent tube: HD Polyethylene
Shield: Aluminum Mylar
Temperature range: -30 to 85°C (-22 to 185°F)
Weight: ~65g/m (0.7 oz/ft)



Global Water
800-876-1172 • globalw.com

V. Introduction

The FL16 Flow Monitor uses Global Water's standard WL6 Level Logger with a redesigned sensor housing and new software to provide a package capable of monitoring water flow in almost any situation including partially full pipes, open channel flumes or weirs, and even streams and rivers. The level transducer is designed to minimize the affects of water velocity, as well as reduce fowling. The FL16 flow software has the ability to calculate and display water flow and velocity in partially full pipes using the Manning's equation, has over 40 pre-stored flume and weir equations, and can access user-defined lookup tables that correlate water level to flow. A special feature allows you to gain maximum accuracy by adjusting parameters to calibrate flow against empirical measurements, before or after the data has been recorded. All of the flow parameters are stored in the logger and are downloaded each time you connect up to the logger. These features allow any gravity fed channel to be monitored using one easy to use product.

The Manning's equation, first proposed in 1889 by Robert Manning, provides a way of calculating flow and velocity in gravity fed channels of known geometry. When applied to circular pipes, it provides accurate flow and velocity information based only on the water level in the pipe, the pipe diameter, the slope and the construction material. Because velocity is a product of this equation, it provides an easy way of checking the calibration of the FL16 against actual velocity measurements, using a velocity probe such as Global Water's FP101 or FP201. Generally, the roughness number corresponding to the pipe's construction material is used to make this adjustment and can compensate for the build-up on the inside of aging pipes. An offset can also be applied to the measured water level to adjust for improper installation in flumes and weirs, or allow for the thickness of the sensor itself when deployed horizontally on the bottom of a pipe or open channel.



Global Water
800-876-1172 • globalw.com

VI. Software Compatibility

Global Water offers various software packages which are compatible with most of our family of data loggers, allowing them to be used in a variety of applications.

The software provided with this data logger is titled “Global Flow Monitor”. Any of Global Water’s FL16 and WL16 Loggers are compatible with this software with one limitation. *The first channel is used to calculate flow and must be a standard unit of level: “Feet, Inches, Meters or cm”.* Flow is calculated based on the water level and it is important to have this well defined.

Starting the software with units other than Feet, Inches, Meters or cm programmed into channel one will generate various warning messages and certain features will not function. The unit and calibration information can be changed in the setup menu as described later in this manual. If a data logger is not compatible with this software package an error message will appear informing you with the problem. To date, the only standard Global Water product which is not compatible with the Global Flow Monitor software is the GL500 data logger. Products with two analog input channels plus battery voltage monitor (regardless of pulse channels) are compatible.

VII. System Requirements:

Desktop or Laptop computer with:

- 1) Windows 98, ME, 2000 or XP (or later) Operating System
- 2) CDROM Drive
- 3) RS-232 COM Port (for FL16S) or USB Port (for FL16U)

Note that the software provided with the FL16 data loggers is for running on desktop and laptop computers only. PDA software is not currently available.



VIII. Software Installation:

Global Logger Installation: *This software is for use on Windows based desktop and laptop computers only.* Insert the software installation CD and run the Setup program in the “Flow Monitor Software” folder. This will install the Global Flow Monitor application in the Program Files folder and automatically put the Global Flow Monitor icon on the desktop.

Serial communication (FL16S Only): If you are using the RS-232 serial port to access the data logger, no further action is needed. You can start using the logger by opening the Global Logger application program. Skip the next section.

USB Driver Installation (FL16U Only): With the installation CD in the CDROM drive and DC power applied to the logger, plug the USB cable into the data logger to open the ADD New Hardware Wizard. *The menus that follow will look different for different operation systems but the procedure is the same. Do not allow the Hardware Wizard to automatically search for the driver. Instead, specify the location (CDROM).* If a generic driver gets, or has been previously installed, it must be uninstalled before proceeding by using the Add or Remove Programs section of the Control Panel. Instead, click the Search External Media box or Specify a Location box and install the driver from the CDROM. Running the Setup program that installs the Global Logger software also installs a folder with the driver in it. This location can also be specified if the CDROM is not available; although, it is recommended that the driver be installed at the same time the Global Logger is installed.

FL16U Only

The following menus apply to the Windows XP operating system.

1) Do not let Windows search for software. Click “No, not at this time” when asked if Windows Update can search for software.





Click Next.

2) Do not let Windows automatically install the software. Click “Install from a specific location”.

Click Next.

3) Specify the location of the driver. Make sure the Global Logger CDROM is in the CD drive and click “Search removable media” only.

Click Next.

FL16U Only

4) The Hardware Wizard searches for the driver.

If Windows advises that the software is not certified, click: “Continue Anyway”.

This only means that Microsoft has not licensed the software. Second party software is allowed and no harm will come to your computer.

5) The first half of the installation is complete. The Hardware Wizard may need to make two passes.

Click Finish.

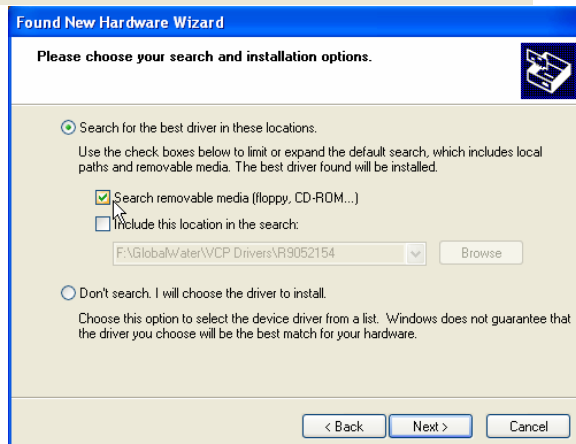
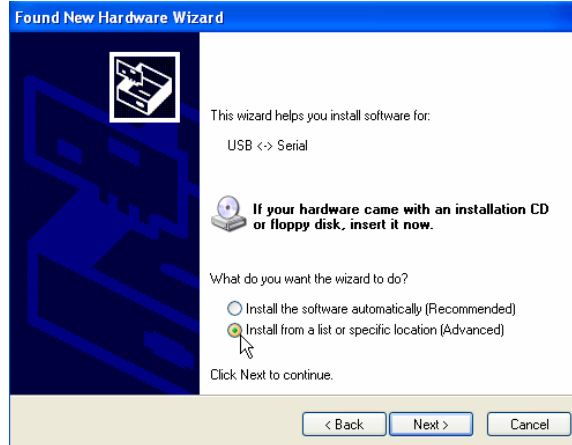



Global Water

800-876-1172 • globalw.com

6) Two drivers are sometimes required so the Hardware Wizard repeats the exact same process again. As before; a: do not let the Windows Update do a search, b: tell Windows to search from a specific location instead of automatically installing software, c: tell Windows to search from removable media (CDROM).

7) The installation is complete.

Click Finish.

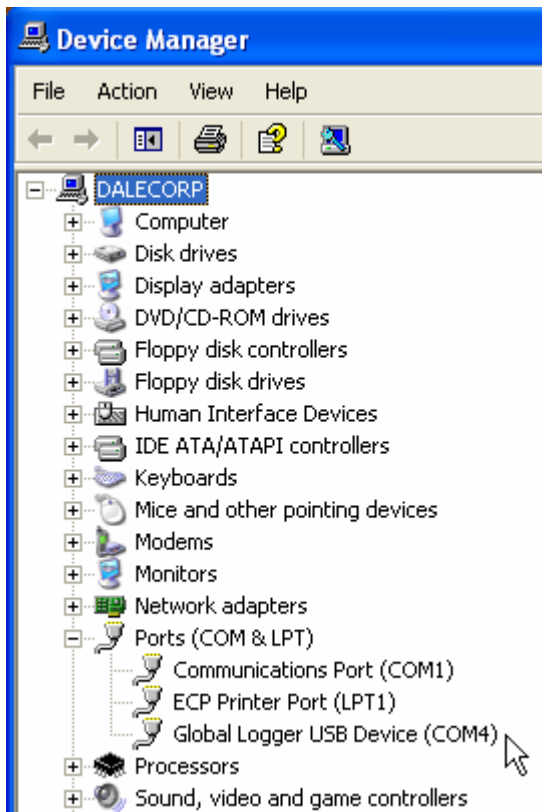
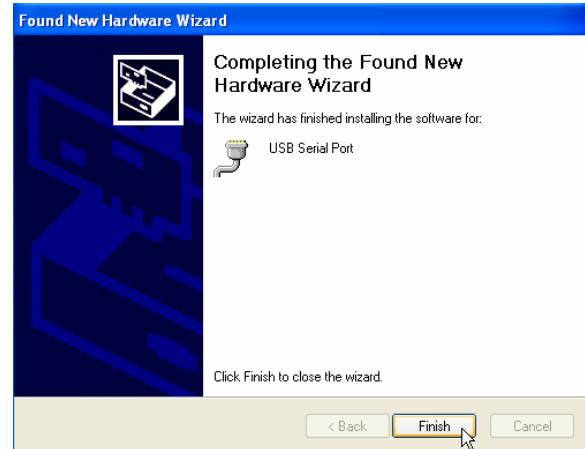

8) To confirm the installation, look in the Device Manager and find the USB Serial Port. The COM setting following that will show the virtual COM port that has been automatically assigned to the driver. As you will see in the following sections, this COM port will be automatically detected by the Global Logger software so it is not necessary to note which port is being used by the driver.



IX. Direct Connection:

Important: This data logger supports an *Auto Baud Rate Mode* which automatically detects the communication speed. However; this communication software also supports loggers which may be programmed in a *Fixed Baud Rate Mode*. This is useful in telemetry applications, particularly when using Global Water data loggers with our Global Access radio modem software. The upcoming discussion assumes that the logger is programmed in auto detect mode. *If you cannot connect to the logger and suspect that the logger may be using a fixed rate mode; try each connection speed separately, especially 38400 which is required when using the Global Access software.* There are 3 ways to connect to the FL16 data Loggers, direct connection through the RS-232 serial port (FL16S only) or USB port (FL16U only), as well as dial out through an installed modem (requires FL16S only with external serial modem).

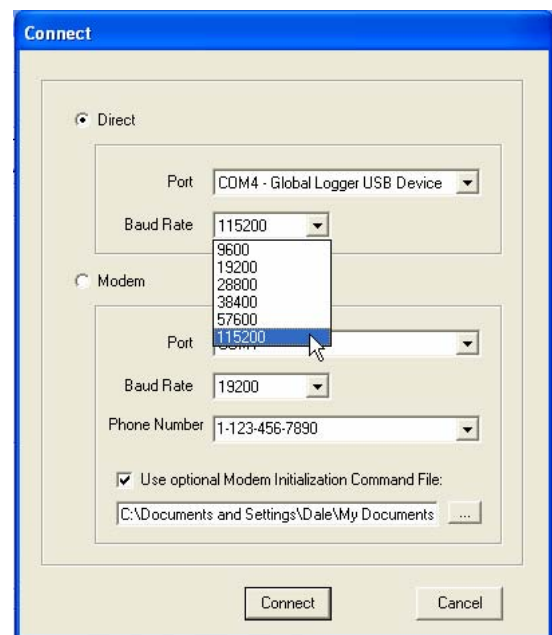
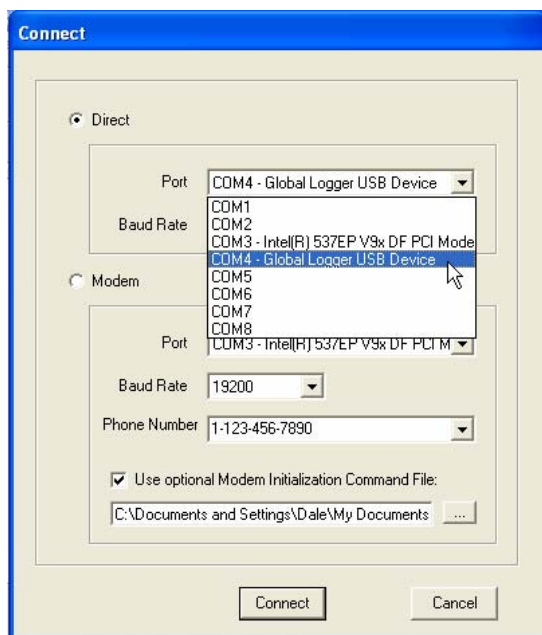

To make a direct connection to the logger, click the “Direct” option and from the “Port” menu, select the port you wish to use.

For USB access (FL16U) select the USB serial port at the COM port the driver was assigned, which is automatically shown in the list as “Global Logger USB Device”.



Serial connection (FL16S) is generally done using the serial cable provided with the logger through the 9-pin COM1 connector at the back of the computer although COM2 can also be used.

Next, select the desired baud rate from the “Baud Rate” menu. Generally, the fastest rate of 115,200 is used although; long cables or other factors may require a slower setting. Click “Connect” to make the connection. If a connection is not made, an error message will appear. Check the battery, communication cable, driver installation and COM port settings.

X. Modem Connection (FL16S Only):

Access to the FL16S can be made through dial-out to a remote modem by clicking the “Modem” option. The connection from modem to logger requires an RS-232 serial modem, USB modems are not supported as an interface to the logger; therefore, the FL16U logger cannot be accessed by modem. Also, some switch settings must be made to the remote modem and an initialization file may be required to properly configure the host modem.

Two baud rates are supported 9600 and 19200. Should you experience difficulty establishing a reliable connection at 19200, try the slower connection speed. Note that due to the slower baud rates and the additional handshaking performed during modem communication, The Global Logger software will operate significantly slower than during a direct connection.

The Global Logger software will remember the last 4 numbers dialed and has a provision for using a stored text file (.txt extension) for initialization of the host modem using standard AT commands. Some experience may be required to configure your modem but a sample command file and some useful tips follow.

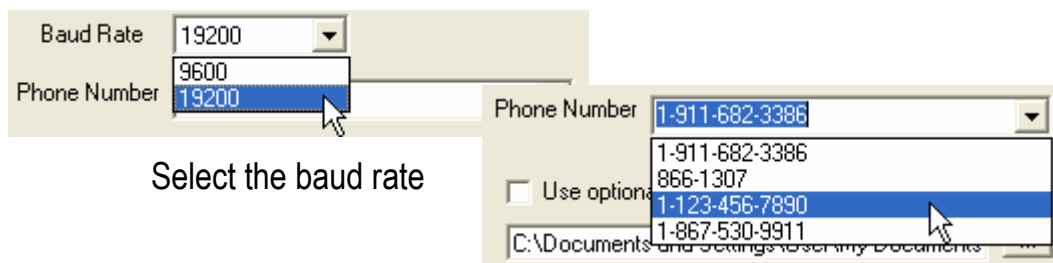

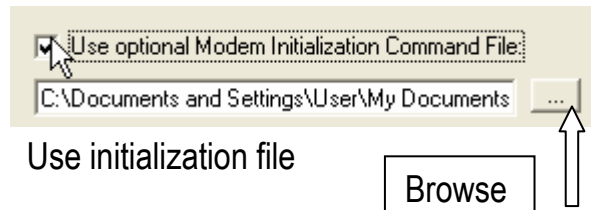
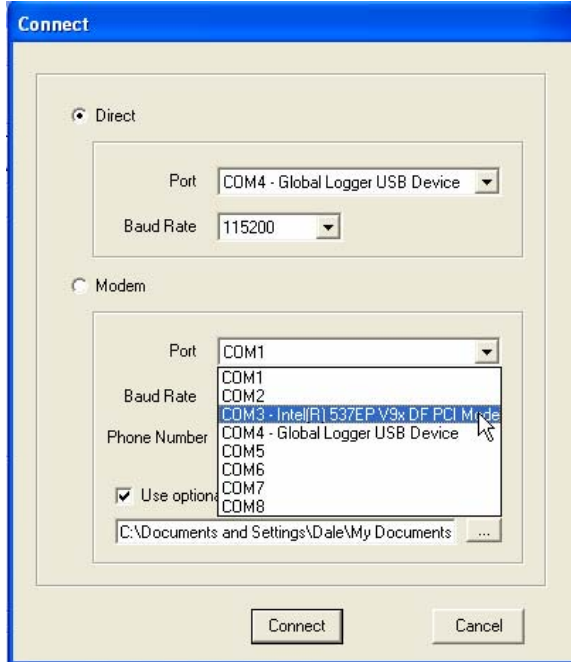

Select the modem's COM port

Sample initialization text file:
This is for reference and applies to an external US Robotics modem only.

ATM1 ; speaker off when connects
AT&B1 ; fixed serial port rate
AT&D2 ; normal DTR
AT&H1&R2 ; h/w flow control
AT&i0 ; disable s/w flow control
AT&K0 ; disable compression
AT&M4 ; normal error control

Select the COM port for your modem and the baud rate. Type in the phone number or select it from the list of pre-stored numbers. If necessary, click the "Use Initialization File" box and use the browse button to search for the initialization text file for your modem. Click "Connect" and the software will dial out, showing the status screen shown above.





Global Water

800-876-1172 • globalw.com

Once a connection is established, "Connect" will appear for a few seconds along with the baud rate of the connection. After connecting, the normal Global Logger screen will appear and operate exactly as if a direct connection was made. All options and features work the same but at a reduced communication speed.

When connecting the FL16S Data Logger to an external modem, a special cable is required. Wiring diagrams are provided at the end of this manual and pre-wired cables are available from Global Water.

The remote modem is configured by setting DIP switches. They should be set to auto-answer on, DTR Normal, carrier detect normal and smart mode. Global Water can provide external modems and interface cables at an additional cost if requested. Contact our sales department for more information.

It may not be necessary to use an initialization string to configure the host modem but if problems arise the modem should be set with software handshaking off (Xoff), DTR normal, fixed baud rate, compression off and error correction on. This configuration is done by building an initialization file using the standard AT commands and loading it into the connection screen.



XI. Main Screen:

The main screen is where the status and option menus are accessed. The FL16 data logger will continue to log at normal intervals while connected to the Global Logger software. While connected, the logger will draw an additional current from the power supply of 5-10mA so it is advised that, if you plan to not access the logger for extended periods of time, you disconnect to increase battery life. Interface cables may remain connected. To disconnect, click on the “Disconnect” button. This label on this button will change to “Connect” and clicking on it will return you to the connection screen as previously discussed.

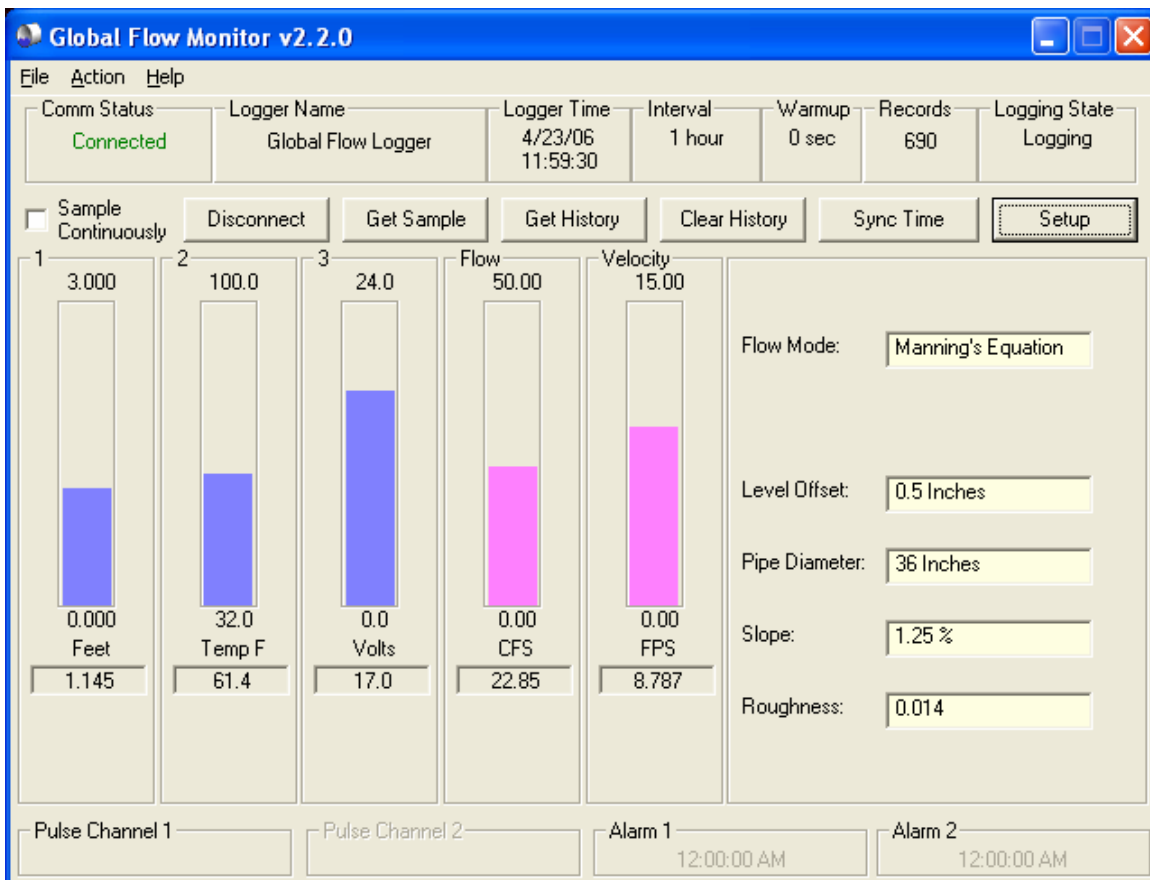

The functions and information in this screen are discussed in the following sections. Note that channel one always displays level, the second channel shows water temperature and channel 3 records battery voltage. Flow is always displayed in the channel to the right of battery voltage. Water velocity is displayed next to flow when using the Manning’s Equation mode only. Flow parameters are shown on the right.



Global Water

800-876-1172 • globalw.com

Tool Bar: The tool bar at the top of the screen has 3 options; File, Action and Help. In this screen, the File option is used to exit the program only. Action allows a menu driven interface to the various functions and displays the hot-keys, which can be used for fast access. In the Help menu; Help allows you to view the on-line help files (see section X, Page 16), About shows contact information and revision information for the Global Logger software and Firmware Version displays the FL16 Data Logger revision number.

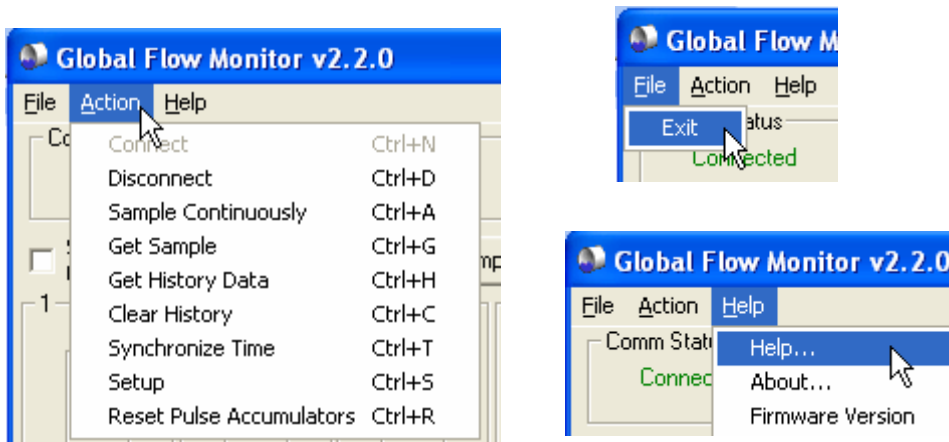

COM Status: This reads “Connected” in green or “Not Connected” in red, depending on the current connection status.

Logger Name: The logger name is a user defined name associated with a particular logger to identify one from another. It is programmed in the Setup menu as described later and is limited to 32 characters.

Logger Time: The time and date displayed is that of the real-time clock in the logger. It is only updated upon initial connection and certain functions that cause data to be read from the logger. These include Sample Continuously, Get Sample, Sync Time and Setup whose functions are to be described later.

Interval: This field displays the logging mode. “Fast” indicates high-speed mode and “Logarithmic” is shown in logarithmic mode. If the logger is in the normal fixed interval sampling mode, the time between samples will be displayed. These modes are to be described later.

Warmup: This displays the sensor warm-up time.



Records: This field indicates the number of data recordings in memory.

Logging State: This shows whether the FL16 is currently logging or waiting to be started or stopped by the alarm timers. These features are described in detail later.

Sample Continuously: Clicking this check box causes the Global Logger software to take and display a real-time reading once per second until stopped by clicking it again, as well as update the rest of the fields on the screen. These data readings are not stored in the historical record and do not affect the normal recording of the logger. The initial reading has a sensor warm-up time of 50mS and the sensor is left powered up until this feature is turned off.

Get Sample: Clicking this button causes the Global Logger software to take and display a single reading as well as update the rest of the fields on the screen. This data reading is not stored in the historical record and does not affect the normal recording of the logger. The sensor warm-up time is fixed at 50mS.

Get History: This button starts the download of all the historical data stored in the logger memory. Oldest data is collected first and Clicking “Stop” halts the process. This function is described in detail later.

Clear History: This resets the number of recordings in memory to zero. The user is warned first and must confirm the action before the memory is cleared.

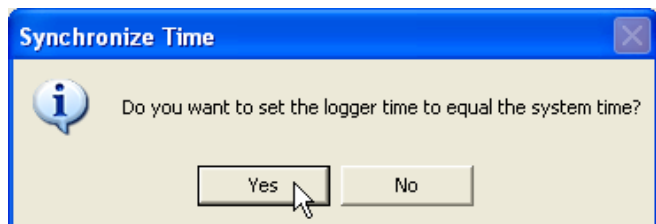
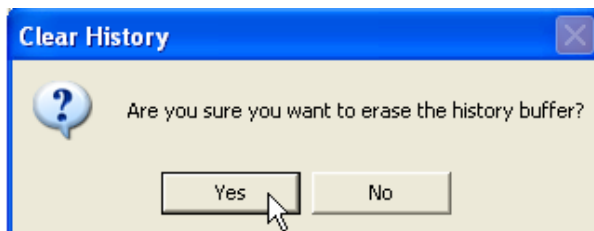

Sync Time: This button causes the data logger’s internal clock to be set to the system time of the computer it is connected to. The user is warned first and must confirm the action before the time is set.

Setup: Clicking this button enters the setup screen where the user can change and program all parameters into the data logger. This function is described in detail later.



Global Water

800-876-1172 • globalw.com

Bar Graphs: The bar graphs show a visual representation of the most recent data reading taken by using the Sample Continuously or Get Sample functions. The upper and lower limits of the display are defined by the user as discussed in detail later. Water flow is displayed always and velocity is displayed when using the Manning's equation

Numerical Reading: The numerical reading at the bottom of the bar graph shows the actual data reading and is updated at the same time as the bar graph. Successive numerical readings taken by using Sample Continuously or Get Sample are shown in a list below the bar, up to 5.

Alarm 1: This field shows the time that the logger is set to start logging. The start alarm is a 24-hour timer which will initiate logging, when enabled, at the next occurrence of that time.

Alarm 2: This field shows the time that the logger is set to stop logging. The stop alarm is a 24-hour timer which will halt logging, when enabled, at the next occurrence of that time after the logger has started recording. If the Alarm 1 timer is set to initiate logging, the Alarm 2 timer will halt logging at the next occurrence of the Alarm 2 time after the logger has been started by Alarm 1. If the Alarm 1 timer is not enabled, the Alarm 2 timer will halt the logger on the next occurrence of that time.

Note: The alarm start and stop cycle is a one time occurrence. Once stopped by the Alarm 2 timer, the logger will not resume logging again until the logger is reprogrammed. Reprogramming the logger with the timers enabled will restart the alarm cycle. Reprogramming the logger with the timers disabled will return the logger to a normal logging state

Use care when programming the alarm times. If left enabled, changing and reprogramming any of the setup parameters will restart the alarm timers and could cause the logger to stop recording.



XII. On-Line Help Files:

Clicking on Help displays the on-line help files which contain all of the information contained in this manual. There are 3 ways to access the information. The first tab is Contents which accesses the table of contents for the manual. Clicking on any of the topics opens up the body of text on that subject. Within each body of text is a discussion of that subject and links to related topics underlined in blue. Clicking on the link will bring up a new window with specific information on that topic. In this case, Sensor Warm-up time in the General Setup menu.

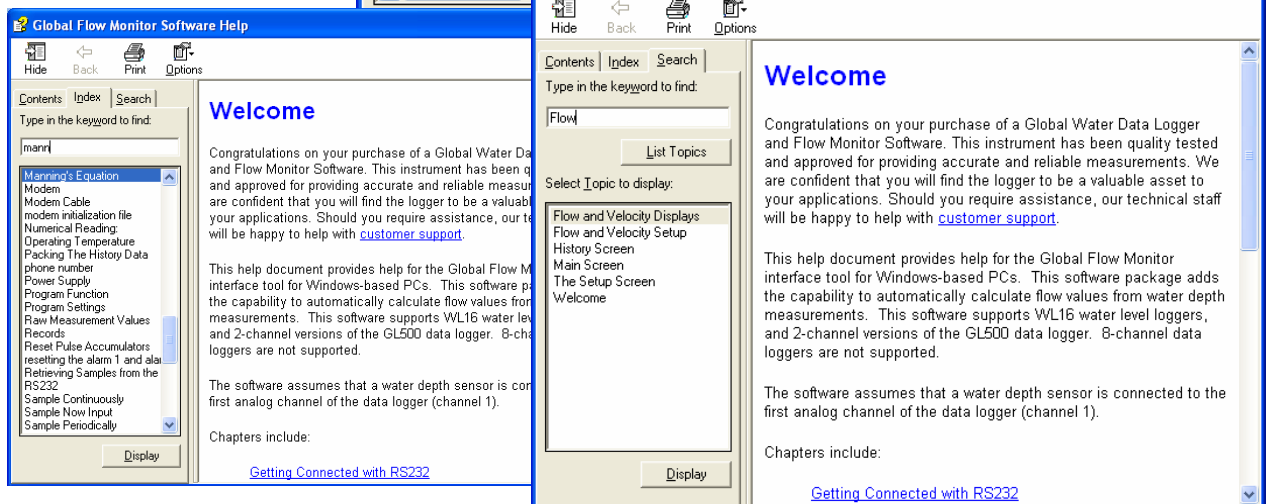
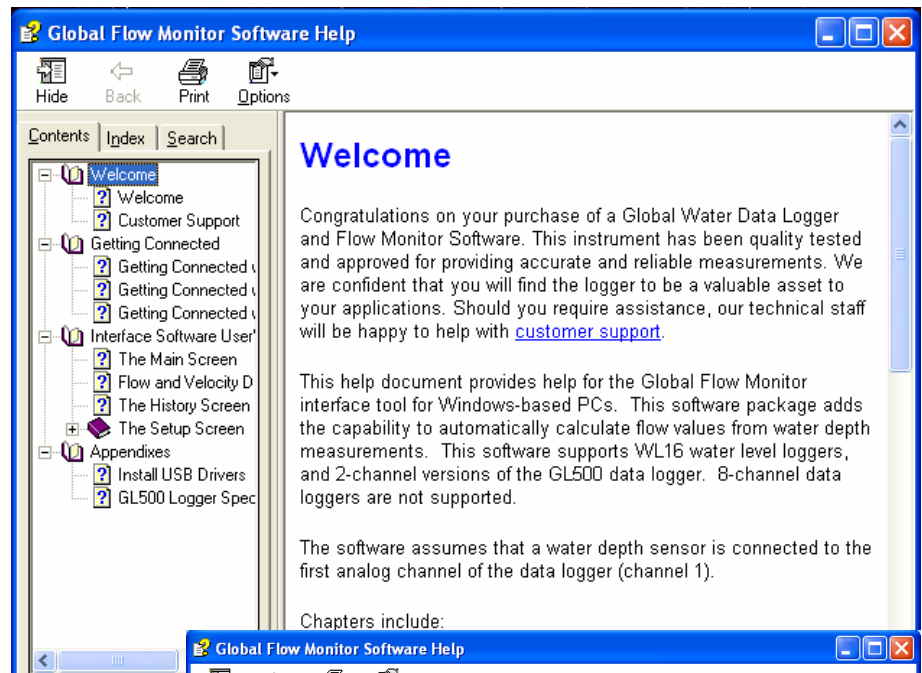

Click the Index tab to find a listing of topics. Type letters into the keyword field and the program automatically sorts the topics alphabetically. To find relevant topics based on a keyword, click the Search tab. Type in a keyword and click List Topics. When the desired topic is found, double-click on it or click Display at the bottom of the screen to show information on that subject.



XIII. Get History:

Clicking the Get History button begins the downloading of the historical data into an information screen. This screen allows the viewing of the recorded data and also provides a path to export the data to an Excel compatible file (.CSV file). Note that the logger continues to log as data is downloaded. Thus, more data points may be downloaded than originally indicated. The recorded level, temperature and battery voltage are displayed, as well as the calculated flow and velocity.

Date / Time	Feet	Temp F	Volts	Flow (CFS)	Vel (FPS)
4/23/06 12:22:13	1.135	61.2	16.9	22.518	8.752
4/23/06 12:22:14	1.135	61.2	16.9	22.518	8.752
4/23/06 12:22:15	1.135	61.2	16.9	22.518	8.752
4/23/06 12:22:16	1.135	61.2	16.9	22.518	8.752
4/23/06 12:22:17	1.135	61.2	16.9	22.518	8.752
4/23/06 12:22:18	1.135	61.2	16.9	22.518	8.752
4/23/06 12:22:19	1.135	61.2	16.9	22.518	8.752
4/23/06 12:22:20	1.135	61.2	16.9	22.518	8.752
4/23/06 12:22:21	1.135	61.2	16.9	22.518	8.752
4/23/06 12:22:22	1.135	61.2	16.9	22.518	8.752
4/23/06 12:22:23	1.135	61.2	16.9	22.518	8.752
4/23/06 12:22:24	1.135	61.2	16.9	22.518	8.752
4/23/06 12:22:25	1.135	61.2	16.9	22.518	8.752
4/23/06 12:22:26	1.135	61.2	16.9	22.518	8.752
4/23/06 12:22:27	1.134	61.2	16.9	22.488	8.749
4/23/06 12:22:28	1.135	61.2	16.9	22.518	8.752
4/23/06 12:22:29	1.134	61.2	16.9	22.488	8.749
4/23/06 12:22:30	1.135	61.2	16.9	22.518	8.752
4/23/06 12:22:31	1.135	61.2	16.9	22.518	8.752
4/23/06 12:22:32	1.134	61.2	16.9	22.488	8.749
4/23/06 12:22:33	1.135	61.2	16.9	22.518	8.752
4/23/06 12:22:34	1.134	61.2	16.9	22.488	8.749

At the top of the screen is shown the name assigned to the logger and the number of recordings that have been retrieved. At the bottom of the screen are three buttons, Pack, Save to File and OK.

Pack: The Pack function removes recordings that are identical to the previous ones. All the channels must be the same as the row above for it to be removed. If even a single channel has data that differs from the previous sample, the row will not be removed. This function works best when a single channel is being recorded and allows only the data showing changing conditions to be viewed.



Save to File: Clicking this button allows the data to be exported to an Excel compatible .CSV file. Specify the path and the file name and click the Save button. *All flow parameters are stored in the header of the .CSV file for easy reference.*

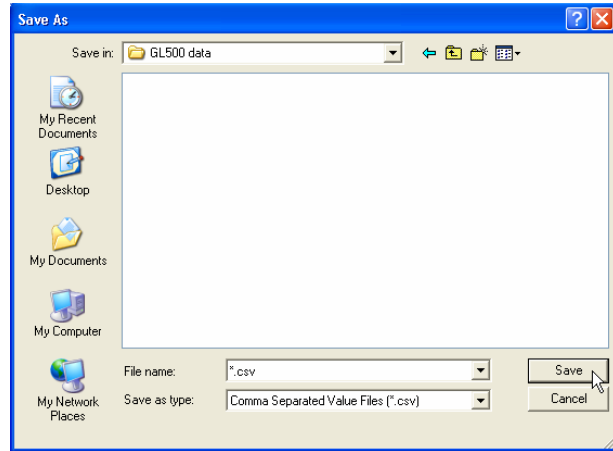

OK: Clicking the OK button returns you to the main screen.

	A	B	C	D	E	F	G	H
1	Global Flow	4/23/2006	12:23:40 PM	Offset= 0.5 Inches	Mannings	Roughness= 0.014	Slope= 1.25 %	Diameter= 36 Inches
2	Date	Time	Feet	Temp F	Volts	Flow (CFS)	Vel (FPS)	
3	4/23/2006	12:22:13	1.135	61.2	16.9	22.518	8.752	
4	4/23/2006	12:22:14	1.135	61.2	16.9	22.518	8.752	

A Typical .CSV File

XIV. Setup Menus:

Clicking the Setup button enters the setup menu which is composed of four sections, Analog, Digital, General and Flow Calculation. The first screen to appear is General Setup. At the top of the setup screen is a toolbar with three options, File, Action and Help.

File: The File option allows you to exit the setup screen but most importantly, it allows all of the configuration information for the logger, including flow parameters, to be saved to a file or restored from a file. Select "Load Setup File" to restore a configuration from a file that has been previously saved or "Save Setup File" to save the current setup and calibration information. The last 4 files are shown for convenience. Setup files have a .SET extension. *It is advised that after you calibrate and configure the logger, you save the configuration to a file as a backup precaution before exiting the setup menu.*

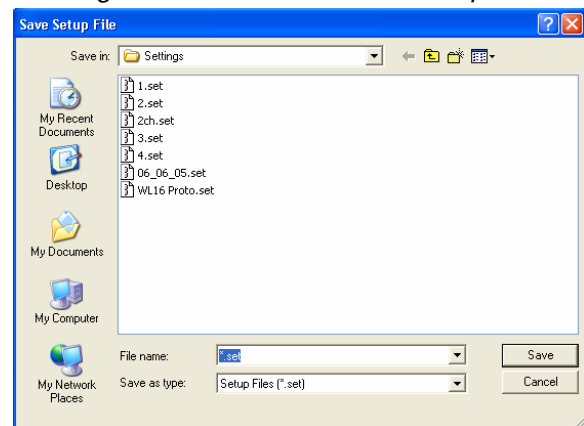
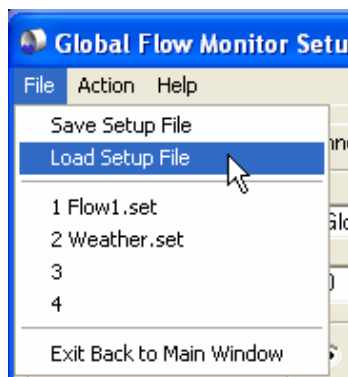



Action: The Action menu has two options, “Program Settings” and “Initialize to Default Values”. Program settings will reprogram the data logger with all the setup and calibration information and works the same as the Program Settings Button at the bottom of the screen. Initialize will restore all of the analog, digital and general setup information fields to default values. Only the setup menus are changed, the data logger must still be programmed with the new default values. A warning message will appear before this action is taken.

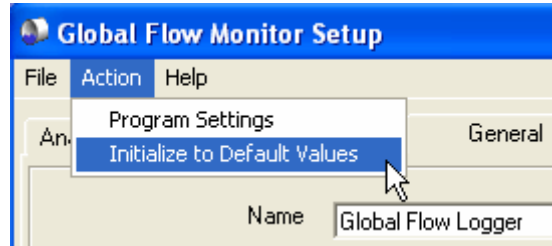

Help: The Help menu provides access to the on-line help files and Global Water contact information as described previously.

XV. General Setup:

In the General Setup menu, the logger name, sensor warm-up time, logging mode, logging interval and alarm times are entered.

XXXXXX

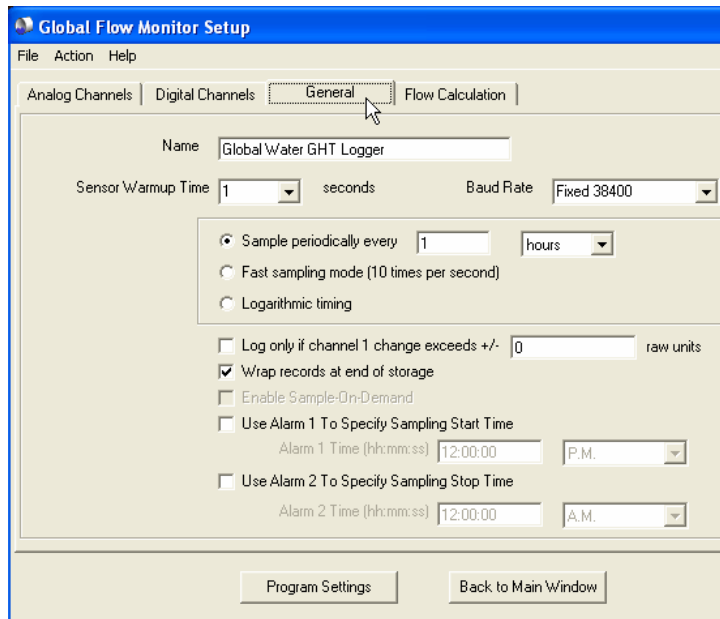

Name: The logger is a user definable name to identify the logger. Up to 32 characters are allowed however, a continuous string of characters of more than 16 with no spaces may not be displayed correctly. Click on the field to enter information.



Sensor Warm-up Time: To conserve battery life, the sensors do not normally have power applied to them. Before taking a reading, the logger powers up the sensors for the sensor warm-up time, and then removes power from them again. The allowable times are zero (50mS) to 15 seconds. Click on the field to enter or select the time in seconds from the pull-down menu.

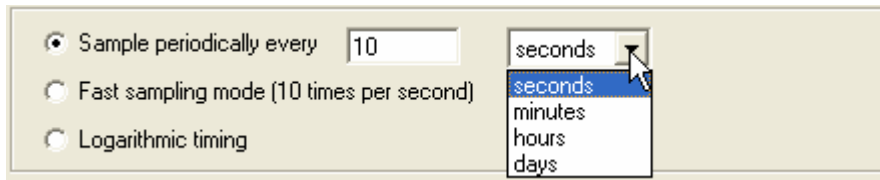
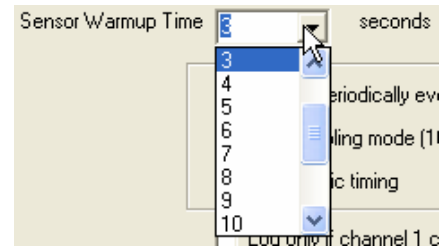

Baud Rate: Leave this set to Auto Baud Rate.

Only change this to a fixed baud rate if planning to use this logger in a telemetry application, such as using Global Water’s Global Access radio modem software. Once programmed in a fixed rate mode, you must set the baud rate in the opening connection menu of the Global Logger II software to this speed, or the logger will not communicate.

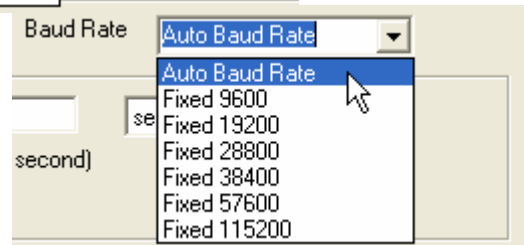

Sample Periodically: Sampling at regular intervals is the most common recording mode. Click the Sample Periodically option, select the units from the pull-down menu and click the numerical field to enter the number of those units up to 65,535.

Fast Sampling Mode: In Fast mode, the sample rate is fixed at 10 times per second. The time stamp will not read fractions of a second so there will be 10 samples per time stamp. Click the Fast mode option to select this feature.

Logarithmic Timing: Typically used in groundwater pump studies, this mode speeds up the sample rate over time. Click the “Logarithmic” option to select this mode. This a logarithmic approximation that steps up the sample rate:

- | | |
|--|---|
| a. 10 times per second for 20 seconds, 200 samples | d. 1 minute interval for 60 minutes, 60 samples |
| b. 1 second interval for 100 seconds, 100 samples | e. 10 minute interval for 10 hours, 60 samples |
| c. 10 second interval for 10 minutes, 60 samples | f. 1 hour interval for 48 hours, 48 samples |
| | g. 1 day interval until memory is full |



Log only if channel 1 change exceeds +/- raw units
 Wrap records at end of storage

Log Upon Deviation: Clicking the “Log only if Channel 1 change exceeds +/-” box causes the logger to record the current reading in memory only if it exceeds the previously reading by the preset amount entered in the numeric field. This logging exception applies to channel 1 only and the deviation is measured in Raw Data units where the approximate raw data range is from 0-65535, corresponding to 0-20mA.

To find the actual number of raw data units per engineering unit, use the calibration numbers in the Analog Setup screen for channel 1 as follows: Raw Data Units per Engineering Unit = (High Raw – Low Raw) / (High EU – Low EU). For example: Assume a 15 foot water level sensor has a High EU of 15, a Low EU of zero, a High Raw of 62256 and a Low Raw of 13104. $(62256-13104) / (15-0) = 3277$ units/foot. Thus, if you want to log only when a reading exceeds the previous on by 0.5 feet, set the deviation to about 1638. Click the numeric field to enter the desired range.

Wrap records: If the “Wrap records at End of Storage” box is checked, once the memory is full, the oldest data points will be replaced with the newest. Thus, the memory block represents only the newest. If this feature is not checked, the logger will halt recording once the memory is full.

Enable Sample-On-Demand
 Use Alarm 1 To Specify Sampling Start Time

Sample-On-Demand: This feature is not supported by the FL16 data loggers.

Alarm Times: Check the box associated with each alarm to enable that feature and enter the desired start or stop time. The logger will start at the next occurrence of the Alarm 1 time and stop at the next occurrence of the Alarm 2 time after the Alarm 1 timer has expired. Either or both alarms can be enabled

Use Alarm 1 To Specify Sampling Start Time
 Alarm 1 Time (hh:mm:ss)
 Use Alarm 2 To Specify Sampling Stop Time
 Alarm 2 Time (hh:mm:ss)

Note: Use care when programming the alarm times. If left enabled, changing and reprogramming any of the setup parameters will restart the alarm timers and could cause the logger to stop recording and the loss of important data.



XVI. Analog Setup:

The Analog Setup screen sets the engineering units and calibration numbers for each of the analog channels, the endpoints of the bar graphs in the main screen and which of the analog channels are enabled. These channels are calibrated in the same way so a single channel will be discussed. *It is important to note here that the information stored in the data logger's memory is just the sensors output level before it is adjusted by the following calibration parameters. These parameters are used to adjust the stored data for display and storage purposes only, at the time the data is downloaded. If they are changed, the same stored data can be downloaded again and the data will be scaled differently according to the new settings.*

	1	2	3	4	5	6	7	8
Enable	<input checked="" type="checkbox"/>	<input checked="" type="checkbox"/>	<input checked="" type="checkbox"/>					
Units	Feet	Temp F	Volts					
High EU	3	100	24					
Low EU	0	32	0					
High Raw	37278	56882	62384					
Low Raw	7808	0	0					
Disp High	3	100	24					
Disp Low	0	32	0					
Decimal Places	3	1	1					
Calibrate	<input type="button" value="Calibrate"/>	<input type="button" value="Calibrate"/>	<input type="button" value="Calibrate"/>					

The calibration of channel one to a water level sensor is discussed in the following example. The water level sensor shown is designed to measure over the range of 0-3 feet but a water column of 3 feet may not be available. The sensors can be calibrated over any range such as 0 to 2 feet, even when it is desirable to measure beyond these limits.



Global Water

800-876-1172 • globalw.com

Enable: If the “Enable” box at the top of a column is checked, data for that channel will be shown in the historical record and be available for export to Excel. The data for all the analog channels is always being recorded whether the channel is enabled or not.

Units: This field shows the units that will appear at the top of the data column for that channel in the historical record as well as the display of data in the main screen. *The FL16 Flow Software requires that the channel one units be Feet, Inches, Meters or cm. No other units will allow flow calculation.*

1
 Enable
Units: Feet
High EU
Low EU

1
 Enable
Units: Feet
High EU: 2
Low EU: 0
High Raw: 25870
Low Raw: 7808
Disp High: 3
Disp Low: 0
Decimal Places: 3
Calibrate

High EU: The High EU field is the engineering unit where the highest output from the sensor is achieved during the calibration process, in this case a water level of 2 feet.

Low EU: The Low EU field is the engineering unit where the lowest output from the sensor is achieved during the calibration process, in this case a water level of zero.

High Raw: This is the raw data value as measured by the FL16 Data Logger that corresponds to the High EU value and is automatically set by the calibration process. In this case, the raw data value returned by the logger at a water level of 2 feet.

Low Raw: This is the raw data value as measured by the logger that corresponds to the Low EU value and is automatically set by the calibration process. In this case, the raw data value returned by a water level of zero.

Disp High: This field sets the upper limit of the bar graph displayed in the main screen and provides a way of scaling the graph beyond the upper limit used to calibrate the logger. In this example, the upper calibration point was a water level of 2 feet but the maximum range of the sensor is 3 feet.

Disp Low: This field sets the lower limit of the bar graph displayed in the main screen and provides a way of scaling the graph beyond the lower limit used to calibrate the logger. In this example, the lower calibration point was a water level of zero.



Decimal Places: From the pull-down menu, select the number of decimal places to the right of the decimal point that should appear in the historical data and in the numerical data field at the bottom of the bar graph.

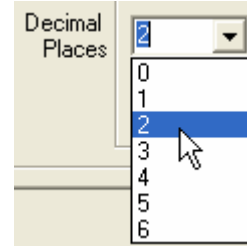

Calibrate: The “Calibrate” button provides a simple 4-step process for calibrating the FL16 Data Logger to a particular sensor. Click the Calibrate button and follow the menu instructions.

Click on the High EU field and enter the high engineering unit that will be used to calibrate the logger, *not the highest reading the sensor can output*. In this example of water level, a depth of 8 feet used to calibrate the logger, even though the sensor can measure up to 15 feet.

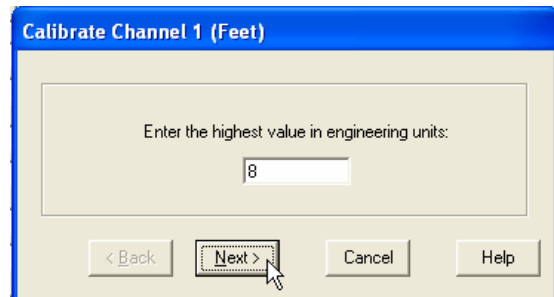

Click Next.

Place the sensor in the condition that will cause it to output the level corresponding to the high EU entered in the previous menu. Wait for the data reading to stabilize.

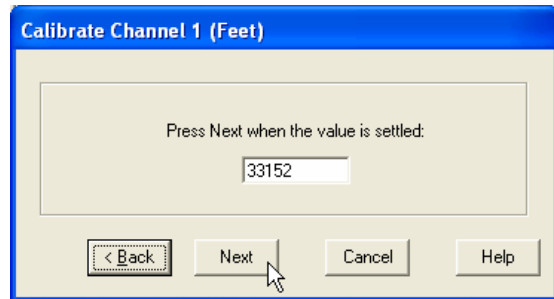

Click Next.

Click on the Low EU field and enter the low engineering unit that will be used to calibrate the logger, *not necessarily the lowest reading the sensor can output*. In this example, the value is zero feet, which is the lowest calibration point and water level.

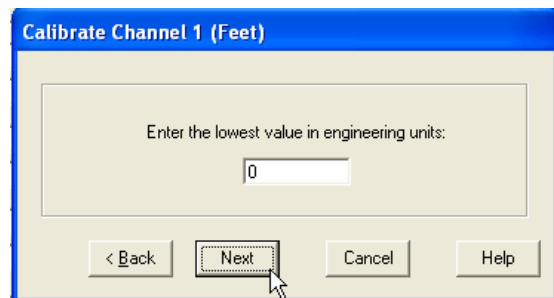

Click Next.

Place the sensor in the condition that will cause it to output the level corresponding to the low EU entered in the previous menu. Wait for the data reading to stabilize. Click Next to complete the calibration.

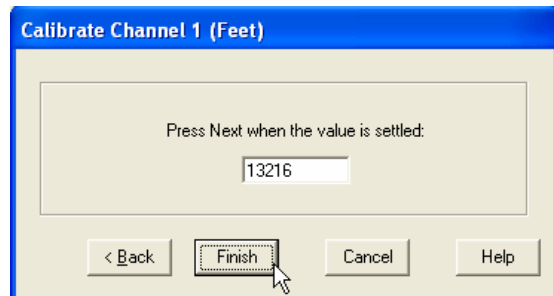



XVII. Flow Calculation Setup:

The Flow Calculation menu is where the flow parameters are set. The five modes supported here are No Flow Calculation, Manning's Equation, Flume, Weir and Table File. When a mode is selected by clicking the button associated with it, only those data fields required for that mode will be displayed, the others will be dimmed.

The screenshot shows the 'Global Flow Monitor Setup' dialog box with the 'Flow Calculation' tab selected. The dialog has a menu bar with 'File', 'Action', and 'Help'. Below the menu bar are four tabs: 'Analog Channels', 'Digital Channels', 'General', and 'Flow Calculation'. The 'Flow Calculation' tab is active and contains the following settings:

- No Flow Calculation
- Manning's Equation
- Flume:
 - 60-degree Trapezoidal
- Weir:
 - 30-degree V-Notch
- Table File:
 - tables\StopsAt0_6ft.tbl
- Flow Display Units: cfs - cubic feet per second
- Flow Display Top Value: 50
- Level Offset: 0.5 inches

The 'Manning's Equation Parameters' section is expanded and contains:

- Pipe Diameter: 36 inches
- Slope: 1.25 percent
- Roughness Number: 0.014
- Velocity Display Units: fps - feet-per-sec
- Velocity Display Top: 15

At the bottom of the dialog are two buttons: 'Program Settings' and 'Back to Main Window'.

No Flow Calculation: In this mode, no flow calculations are done. The main screen will show level, temperature and battery voltage only; as will the downloaded historical record.

Manning's Equation Mode:

The Manning's Equation predicts flow and velocity in gravity fed open channels but in this software, is limited to partially full round pipes. Since velocity is a product of this equation, it allows for an easy way to check the calculated data by measuring water velocity with a probe. Flow and velocity are shown on the main screen as



separate bar graphs and are both stored; along with the level, temperature and battery voltage data in the historical record.

The information required for the Manning's equation is:

Pipe Diameter: The inside diameter of the pipe. The possible units of measurement are Feet, Inches, Meters or centimeters, which are selected from the pulldown menu to the right of the data field. Click on the field to enter the diameter.

Slope: The slope of the pipe can be in % or decimal form. A slope of 1.25% is entered as 1.25 when the percent units are selected and 0.0125 in decimal.

Roughness Number: This number, commonly referred to as the Manning's number or "n", is a measure of how much friction there is between the water flow and the inside pipe wall. While all surfaces are different and the roughness changes over time, a look-up table is provided by clicking the arrow to the right of the data field.

This number is the one most commonly used to adjust the calculated flow velocity to match empirical measurements when calibrating the FL16 to a particular pipe.

Flumes Mode:

When the Flume mode is selected, a list of pre-programmed flume equations is available. Click the arrow next to the display field and access the list. If a flume is not on the list, the custom look-up table feature of this software can be used as described later. In this mode, the bar graph and historical will include flow but not velocity.

Weirs Mode:

As with flumes, this mode allows access to a list of weirs stored in the software. Click the arrow next to the display field and access the list. The display

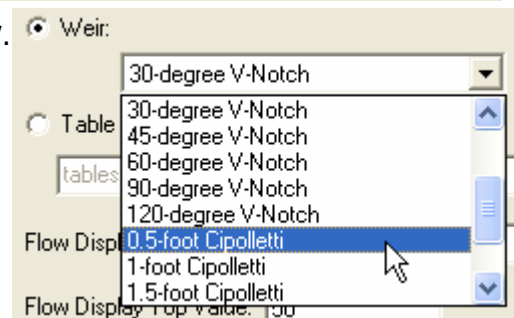
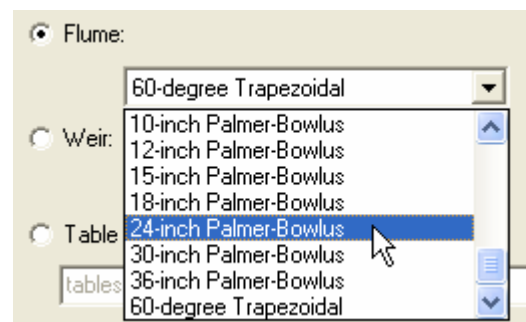
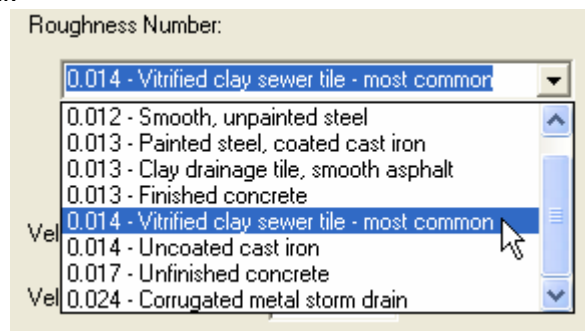
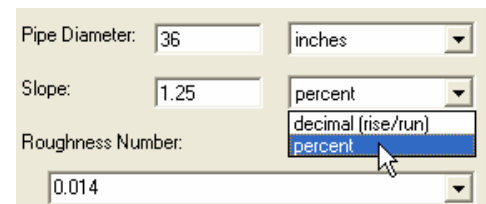
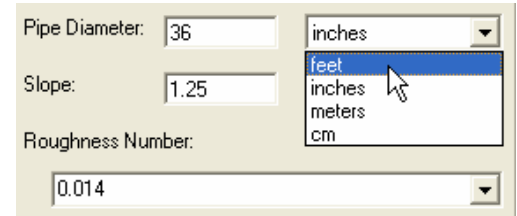



Table File Mode:

This powerful feature allows you to load a user defined tables for correlating level measurements to flow. The table file is a text file with each line containing a water level in feet, followed by the corresponding flow in cubic feet per second, separated by either spaces or commas. You can adjust the flow units in software but the units in this file must be Feet and CFS. A descriptive header of any length can be included at the top of the file to describe it. The file must contain at least two and no more than 1000 entries, and have a .tbl extension. While not required, it is recommended that the file be stored in the “Tables” directory where the flow software is installed. The level must be increasing as the lines of the file progress and it is assumed that if there is no level of zero in the table, it will correspond to a flow of zero. The path and file name of this table are stored in the logger along with all other configuration information, but the table information is not. Connecting the FL16 logger to a computer without this file stored in the correct folder will generate warning messages and will prevent water level data from being converted to flow until the file is found.

Table File:
tables\0_6HS.tbl

	A	B	C
1	Global Water, 0.6HS Flume		
2	Ft	CFS	
3			
4	0	0	
5	0.01	0	
6	0.02	0.00023	
7	0.03	0.00053	
8	0.04	0.00091	
9	0.05	0.00138	
10	0.06	0.00193	
11	0.07	0.00259	
12	0.08	0.00335	

Display Parameters:

These parameters control the way the flow and velocity data is displayed in the bar graphs on the main screen only, they do not affect recorded data in any way. For the Manning’s equation mode, both water flow and velocity are displayed. Flumes, weirs and lookup tables will show flow only.

Flow Display Units: cfs - cubic feet per second
 Velocity Display Units: fps - feet-per-sec
 Flow Display Top Value: 50
 Velocity Display Top: 15

The available units are selected from pulldown menus and the number corresponding to the top of the bar graph is typed into the data field.

Velocity Display Units: fps - feet-per-sec
 Velocity Display Top: fps - feet-per-sec

Flow Display Units: cfs - cubic feet per second
 Flow Display Top Value: gpm - gallons per minute
 Level Offset: mgd - million's of gallons per day
 cms - cubic meters per second
 lps - liters per second



Global Water

800-876-1172 • globalw.com

Level Offset:

This setting lets you add or subtract a specified amount to or from the measured water level to compensate for errors in installation and other factors that affect the accuracy of your flow measurements. A positive number is added to measured level and a negative number is subtracted from it. Note that this offset is used when making flow calculations only. It does not affect the water level data displayed or recorded by channel one of the data logger.

The offset number is used to adjust any positive non-zero level. When the sensor is out of water, it may not read exactly zero. If this small error is a positive number, regardless of how small, the offset will be added to it resulting in a small flow being shown. If the offset value is a negative number, it will be subtracted from the measured level but the result will never be less than zero. The offset number is intended to be used in a condition where the sensor is submerged most or all of the time so that incorrect readings near zero do not introduce errors.

Sensor Installed Horizontally:

The level sensor supplied with the FL16 has an outer diameter of one inch and the sensing element itself is in the center. When the sensor is installed horizontally on the bottom of a pipe, it will not begin to read water level until the level is already one half inch deep. Adding a 0.5 inch offset will compensate for this and allows the flow to be calculated based on actual level, not measured.

Level Offset: inches ▾

Level Offset: inches ▾
feet
inches
meters
cm

Program

Sensor Installed Vertically:

When the sensor is installed vertically in an open channel, it does not need to be installed at the critical measurement point but rather, can be installed at any point and the offset number can be used to adjust the height of the sensor in software. It may be desirable to install the sensor off of the bottom of a stream or river to prevent silting or damage from rocks. If the sensor is installed too high, use a positive offset number to add the distance to the bottom and “lower” it. If the sensor is installed too low, such as below the sill in a Palmer-Bowlus flume, use a negative offset to subtract off the error from the actual measured level and “raise” the sensor.



XVIII. Programming

Program Settings: The Program Settings button at the bottom of the setup menus will cause all the setup and calibration information to be programmed into the data logger. A warning will appear requiring the use to confirm the action. Click Yes to program the logger and No to cancel the operation.

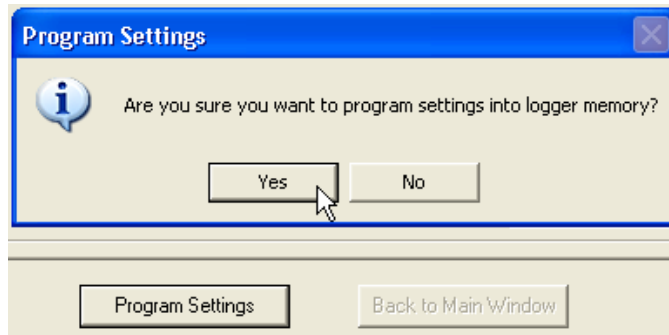

Back to Main Window: The Back to Main Menu button exits back to the main screen. If no settings have changed, Exit will occur immediately. If settings have changed but not saved yet, a message will appear that asks the user if they would like to save them now. If the settings have changed but not yet programmed into the logger, another message will be shown asking if the logger should be reprogrammed.

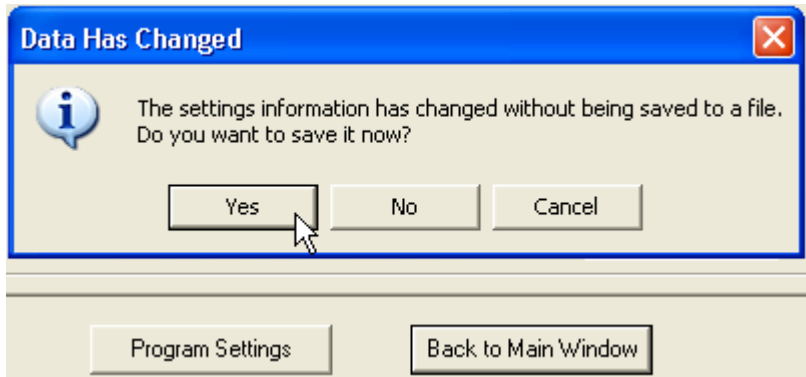

These layers of protection are designed to prevent the user from unintentionally changing settings or forgetting to save the configuration file. Should the settings accidentally be changed, a saved configuration file can be loaded and used to restore the original settings.

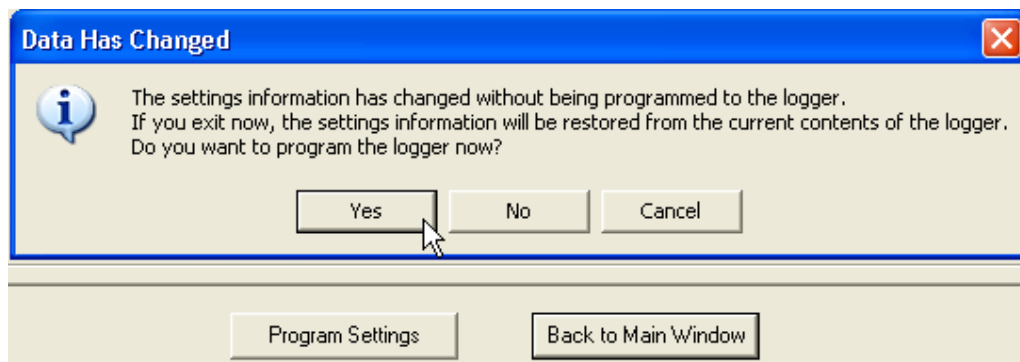



XIX. Calculations:

Manning's equation:

$$\text{Velocity} = (1.486 / n) * (WA / WP) ^ 0.6667 * (\text{Slope}) ^ 0.5$$
$$\text{Flow} = (1.486 / n) * (WA) * (WA / WP) ^ 0.6667 * (\text{Slope}) ^ 0.5$$

Where n = Manning's Roughness Number
 WA = Wetted Area in square feet, based in measured level
 WP = Wetted Perimeter in feet, based in measured level
 Slope = Pipe Slope in decimal form
 Velocity is in feet per second
 Flow is calculated in cubic feet per second

Flumes and Weirs:

Most of the stored flumes and weirs have equations in the form of:

$$\text{Flow} = C * (H+A)^B$$

Where A is a level offset number, generally zero
 B is an exponent
 C is a multiplier
 H is the measured water level in feet
 Flow is calculated in cubic feet per second

Flumes and weirs not appearing in the pull-down lists can be added by modifying the flumes.lst and weirs.lst files. These are text files stored in the folder containing the FL16 Flow software and can be edited in a text editor. The format of these files is described in the header at the top of each one. Adding flumes or weirs to the list consists of specifying the name as it will appear in the menu as well as the coefficients in the equation listed above or a file name for the lookup table that will be used to correlate flow to level. Note that if the logger is programmed to use a flume or weir that has been added to this list, an error message will appear when the logger is connected to a computer which does not have the correct flumes or weirs .lst file.



Global Water
800-876-1172 • globalw.com

XX. Modem Cable Diagram (FL16S Only):

The following wiring diagram is used to make a cable to connect the FL16S Data Logger to an external modem. A pre-wired cable is available from Global Water.

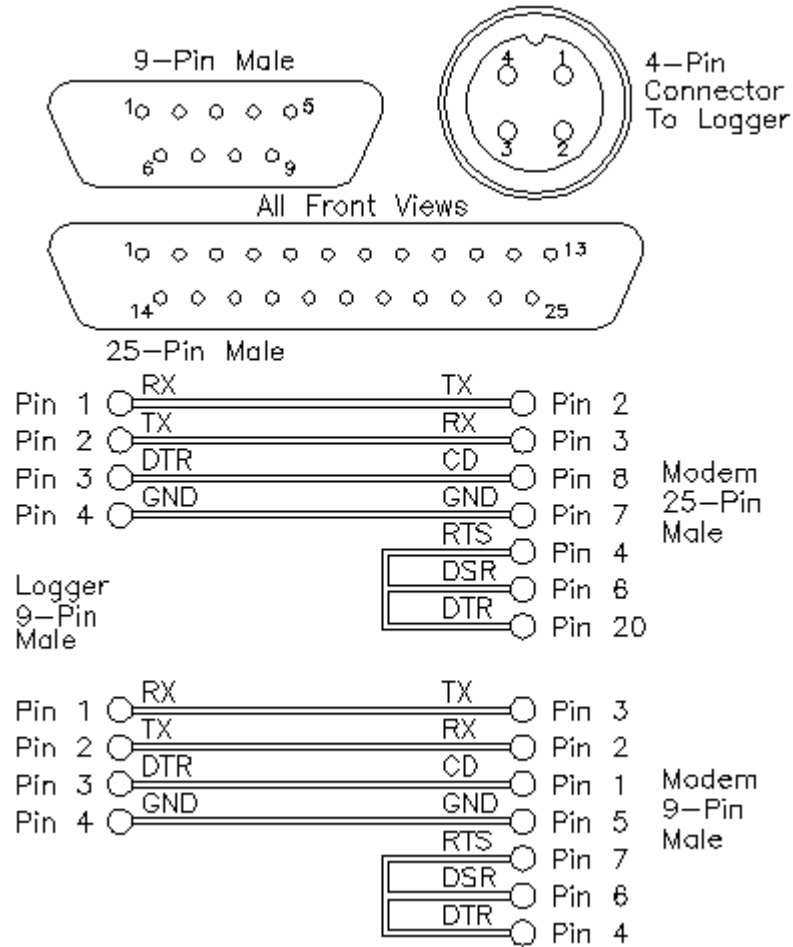



Global Water
800-876-1172 • globalw.com

XXI. Maintenance:

- a. Except for battery and desiccant, there are no user-serviceable parts inside the FL16 Data Logger.
- b. Global Water recommends checking the batteries every 6 months.
- c. Clean the sensor housing and screen using clean water and a small brush to remove any debris. To clean, remove the set screw holding the end on to the stainless steel housing.

XXII. Troubleshooting:

Issue: Logger is reading incorrectly.

- a. Verify the battery supply has enough voltage. To operate properly, the logger and sensor must have a minimum of 8 volts but if the battery voltage monitor is reading less than 15 volts or seems incorrect, check the batteries with a voltmeter or replace them. Battery voltages of less than 15 volts indicate that the batteries need replacing.
- b. Check the logger and sensor calibration numbers in the Setup Menu. Recalibrate the logger if necessary. As a precaution, save the setup file first as described in section XI.

Issue: Cannot communicate with the logger.

- a. Verify that good batteries are installed.
- b. Check the communication cable.
- c. If the connection is to the FL16S using the serial cable provided by Global Water, verify that the correct COM port is selected in the connection menu of the Global Logger software.
- d. If the connection is to the FL16U through the USB port, use the Device Manager to confirm that the driver is loaded and the correct virtual COM port is selected in the connection menu of the Global Logger software. Check the Device Manager in your operating system and confirm that the USB COM port is not being used by another device.
- e. Try reducing the baud rate in the connection screen of the Global Logger software.



Global Water
800-876-1172 • globalw.com

XXIII. Customer Support:

Call Global Water for tech support: 800-876-1172 or 916-638-3429 (many problems can be solved over the phone). Fax: 916-638-3270 or Email: globalw@globalw.com.

When calling for tech support, have the following information ready:

1. Model #.
2. Unit serial number.
3. P.O.# the equipment was purchased on.
4. Our sales number or the invoice number.
5. Repair instructions and/or specific problems relating to the product.

Be prepared to describe the problem you are experiencing including specific details of the application, installation, and any additional pertinent information.

In the event that the equipment needs to be returned to the factory for any reason, please call to obtain an RMA# (Return Material Authorization). Do not return items without an RMA# displayed on the outside of the package. Include a written statement describing the problems.

Send the package with shipping prepaid to our factory address. Insure your shipment; Global Water's warranty does not cover damage incurred during transit.