



# 2020

# TURBIDIMETER

.....



**Instruction  
MANUAL**



# TABLE OF CONTENTS

---

## GENERAL INFORMATION

Packaging and Delivery . . . . .	4
General Precautions . . . . .	4
Safety Precautions . . . . .	4
Limits of Liability . . . . .	4
Specifications . . . . .	5
Parts & Accessories . . . . .	6
EPA Compliance . . . . .	6
Warranty. . . . .	6
CE Compliance . . . . .	7

## INTRODUCTION

What is Turbidity? . . . . .	8
How is Turbidity Measured? . . . . .	9-10

## GENERAL OPERATING INFORMATION

Overview . . . . .	11-12
The Keypad . . . . .	13
The Display . . . . .	13
Turbidity Tubes . . . . .	14-15

## CALIBRATION

Standard Solutions . . . . .	16
Calibration Procedure . . . . .	17

## ANALYSIS PROCEDURES WITH THE 2020

Selecting the EPA Mode . . . . .	18
Turbidity Measurement. . . . .	19
Preparation of Turbidity-Free Water . . . . .	20-21
Dilution Procedures . . . . .	22
Testing Tips. . . . .	22

## TROUBLESHOOTING GUIDE. . . . . 25

## RS232 PORT . . . . . 24

## MAINTENANCE OF THE 2020

Replacing the Battery. . . . .	25
Replacing the Lamp . . . . .	25
Repairs to the 2020. . . . .	25

## **GENERAL INFORMATION**

---

### **PACKAGING & DELIVERY**

---

Experienced packaging personnel at LaMotte Company assure adequate protection against normal hazards encountered in transportation of shipments. After the product leaves the manufacturer, all responsibility for safe delivery is assured by the transportation company. Damage claims must be filed immediately with the transportation company to receive compensation for damaged goods.

Should it be necessary to return the instrument for repair or servicing, pack the instrument carefully in a suitable container with adequate packing material. A return authorization number must be obtained from LaMotte Company by calling 1-800-344-3100 or faxing 1-410-778-6394. Attach a letter with the authorization number to the shipping carton which describes the reason for the return. This information will enable the service department to make the required repairs more efficiently.

### **GENERAL PRECAUTIONS**

---

Read the instruction manual before attempting to set up or operate this instrument. Failure to do so could result in personal injury or damage to the instrument.

The 2020 Turbidimeter should not be stored or used in a wet or corrosive environment. Care should be taken to prevent water from wet turbidity tubes from entering the turbidimeter light chamber.



**NEVER PUT WET TUBES IN THE TURBIDIMETER.**

### **SAFETY PRECAUTIONS**

---

Read the label on all reagent containers. Some labels include precautionary notices and first aid information. Certain reagents are considered hazardous substances and are designated with a \* in the instruction manual. Material Safety Data Sheets (MSDS) are supplied for these reagents. Read accompanying MSDS before using these reagents. Additional emergency information for all LaMotte reagents is available 24 hours a day from the Poison Control Center listed in the front of the phone book. Be prepared to supply the name and four digit LaMotte code number found on the container label or at the top of the MSDS. LaMotte reagents are registered with a computerized poison control information system available to all local poison control centers.

### **LIMITS OF LIABILITY**

---

Under no circumstances shall LaMotte Company be liable for loss of life, property, profits, or other damages incurred through the use or misuse of their products.

# SPECIFICATIONS

Instrument Type	Nephelometric turbidity, calibrated in NTU																	
Range	0.00 -1100 NTU																	
Accuracy	.05 or $\pm 2\%$ for readings below 100 NTU, whichever is greater $\pm 3\%$ above 100 NTU																	
Resolution	<i>Standard Mode</i> 0.01 from 0.00 -10.99 NTU 0.1 from 11.0 -109.9 NTU 1 from 110 -1100 NTU  <i>EPA Mode</i> <table border="0"> <thead> <tr> <th>NTU</th> <th>Reported to the nearest NTU</th> </tr> </thead> <tbody> <tr> <td>0 - 1.0</td> <td>0.05</td> </tr> <tr> <td>1.0 - 10</td> <td>0.1</td> </tr> <tr> <td>10 - 40</td> <td>1</td> </tr> <tr> <td>40 - 100</td> <td>5</td> </tr> <tr> <td>100 - 400</td> <td>10</td> </tr> <tr> <td>400 - 1000</td> <td>50</td> </tr> <tr> <td>1000</td> <td>100</td> </tr> </tbody> </table>		NTU	Reported to the nearest NTU	0 - 1.0	0.05	1.0 - 10	0.1	10 - 40	1	40 - 100	5	100 - 400	10	400 - 1000	50	1000	100
NTU	Reported to the nearest NTU																	
0 - 1.0	0.05																	
1.0 - 10	0.1																	
10 - 40	1																	
40 - 100	5																	
100 - 400	10																	
400 - 1000	50																	
1000	100																	
Display	3½ digits																	
Response Time	5 seconds																	
Warm-up time	Not required																	
Automatic Shut Off	2 minutes																	
Lamp	Tungsten Filament bulb (approximate life 800 hours)																	
Sample	15 mL in capped tube																	
Sample Chamber	Accepts 25mm diameter flat-bottomed tubes (capped)																	
Power source	Battery Operation: 9 Volt Alkaline Line Operation: 120V/50Hz, 220V/60Hz*, with supplied adapter																	
Size (L X W X H)	8.5 x 16.2 x 6.7 cm, 3.4 X 6.4 X 2.6 inches																	
Shipping Weight	Meter only: 11 oz. (312g) Kit: 3 lb. 7 oz. (1560g)																	
Serial Interface	RS232, 8 pin mDIN, 9600b, 8, 1, n																	

\*CE Mark: The devise complies to the product specifications for the Low Voltage Directive when furnished with the 220V AC Adapter (Code 1774). The 120V AC adapter is not CE approved.

## PARTS & ACCESSORIES

Included in the Model 2020 Turbidity Meter Kit (Code 1799 OR 1799-EX2):

Code	Item
26856	2020 Turbidity Meter
1726-110	AC Adapter, 9V (or 1726-220 with 1799-EX2)
1476	AMCO™ 2020 Turbidity Standard, 1.0 NTU, 60 mL
1477	AMCO™ 2020 Turbidity Standard, 10 NTU, 60 mL
0286-4	Turbidity tubes, set of 4

### Optional Accessories:

1478	AMCO™ 2020 Turbidity Standard, 100 NTU, 60 mL
1479	AMCO™ 2020 Turbidity Standard, 250 NTU, 60 mL
1800	High Turbidity Dilution Kit includes: Syringe, Filter Holder, Membrane Filters
0943	Syringe
0598	Filter holder
1103-6	Membrane Filters, 0.45 micron, pkg of 6
5115PS-H	Deionized Water, 60 mL
6195-H	Formazin Turbidity Standard, 4000 NTU, 60 mL

## EPA COMPLIANCE

This instrument meets or exceeds EPA design specifications for NPDWR and NPDES turbidity monitoring programs as specified by the USEPA method 180.1. There is also a compliance reading mode which rounds the reading to meet EPA reporting requirements.



## WARRANTY

This instrument is guaranteed to be free from defects in material and workmanship for one year from original purchase date. If within that time the instrument is found to be defective, it will be repaired without charge except for transportation costs. The guarantee does not cover batteries.



# CE COMPLIANCE

---

The 2020 Turbidimeter has been independently tested and has earned the European CE Mark of compliance for electromagnetic compatibility and safety.



## DECLARATION OF CONFORMITY

---

**Application of Council Directives:** 89/336/EEC

**Standards to which Conformity Declared:** EN55022, EN50082-1, En600950

**Manufacturer's Name:** LaMotte Company

**Manufacturer's Address:** 802 Washington Avenue  
PO Box 329  
Chestertown, MD 21620

**Importer's Name:** Reagecon Diagnostics Ltd

**Importer's Address:** 13 A/D Shannon Free Zone  
Shannon, Co. Clare. Ireland

**Type of Equipment:** Water Quality Meters

**Model Number:** 2020/1200

**Year of Manufacture:** 1997

---

*I, the undersigned, hereby declare that the equipment specified above conforms to the above Directive and Standards.*

Chestertown, Maryland  
\_\_\_\_\_  
**Place**

3-19-97  
\_\_\_\_\_  
**Date**

*James K. Trumbauer*  
\_\_\_\_\_  
**Signature**

James K. Trumbauer  
\_\_\_\_\_  
**Name**

V.P., Director of Research & Development  
\_\_\_\_\_  
**Position**

NOTE: The device complies to the product specifications for the Low Voltage Directive when furnished with the 220V AC Adapter (Code 1774).

# WHAT IS TURBIDITY?

---

Turbidity, cloudiness in water, can be interpreted as an absence of clarity or brilliance. It is caused by suspended and colloidal matter such as clay, silt, organic and inorganic matter and microscopic organisms. Turbidity should not be confused with color since a darkly colored water can still be clear and not turbid.

Turbid water is often an indicator of conditions that could cause damage to manufacturing equipment. Water clarity is especially important to the producers of consumer products such as beverage producers, food processors and water treatment plants. The particulates that cause turbidity may not always be harmful to human health, but are considered an undesirable characteristic.

Turbidity in industrial water used for boiler and cooling systems should be as low as possible. In boilers, the particles may become concentrated and settle out as a sludge that will damage equipment and cause foaming. In cooling water systems, particles can interfere with corrosion inhibitors. Water clarity is improved with fluid-particle separation processes such as sedimentation, coagulation and filtration.

In swimming pools, cloudy water is a common problem. The usual causes for poor water clarity are corrosion, improper filtration and/or improperly balanced water. An algae condition or severe chloramine condition can also cloud pool water.

In natural waters, turbidity is an indicator of quality and productivity and can be used to monitor the health of streams and lakes. Turbid water may indicate runoff from construction, agriculture or other types of pollution. Suspended sediment can carry nutrients and pesticides throughout the water system. Suspended particles near the surface absorb additional heat from sunlight, raising the water temperature and blocking out the light needed by submerged aquatic vegetation and bottom dwelling creatures.





## HOW IS TURBIDITY MEASURED?

Light passing through clear water will travel in a straight line. Particles in turbid water will cause the light to scatter giving it a “cloudy” appearance. The turbidity of a sample is determined by measuring the amount of scatter when a light is passed through a sample. The higher the turbidity, the greater the amount of scatter.

Turbidity can be measured in many ways. Visual methods include, the comparative methods, the Secchi disk method and the Jackson Candle method. Comparative methods are used in shallow water and determine turbidity by matching the turbidity of a water sample to a standard of known turbidity either with a “target” at the bottom of a tube or with a turbidity comparator. In the deeper waters of lakes, ponds, rivers and estuaries the Secchi disk is often used to measure turbidity. The Secchi disk is a disk about eight inches in diameter that is either white or is marked with black and white quadrants. The disk is lowered into the water on a calibrated line and the depth is noted where the disk just disappears from sight. The disk is then raised until it is visible. The average of these two distances is known as the “Secchi depth”.

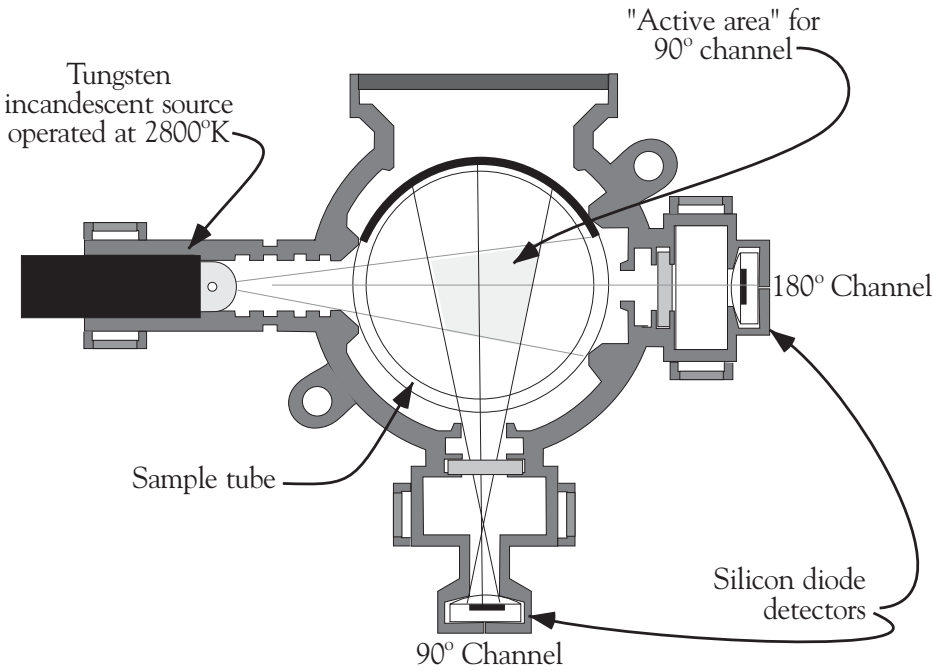

2020 Nephelometer

At waterworks and wastewater treatment plants the Jackson Candle apparatus was a standard instrument for measuring turbidities of incoming raw waters and treated wastewater effluents for many years. The equipment was modified over time but originally it consisted of a long glass tube supported over a “standard candle.” Water was added to or removed from the tube until the image of the candle flame became indistinct. The depth of the water in the tube was read off a calibrated scale etched into the side of the tube, and results were reported numerically as Jackson Turbidity Units (JTU). The lowest turbidity that can be determined with this method is 25 Nephelometric Turbidity Units (NTU). Since the EPA’s Surface Water Treatment requirements state that, finish water from municipal treatment plants will have a turbidity less than 1 NTU, indirect methods were developed to measure turbidity. Turbidimeters are the preferred method.

Nephelometers, such as the 2020, are turbidimeters that measure the scattered light at 90 degrees from the light source. A reference beam passes through the sample and is measured at 180 degrees. The ratio of these two readings is electronically converted to a turbidity measurement in NTU.

# GENERAL OPERATING INFORMATION

## OVERVIEW

The 2020 Turbidimeter is a portable, microprocessor controlled nephelometer. A multi-detector optical configuration assures long term stability and minimizes stray light and color interferences. All readings are determined by the process of signal averaging over a 5 second period, minimizing fluctuations in readings attributed to large particles and enabling rapid, repeatable measurements. It has a sealed keypad. The microprocessor enables auto-ranging over the full range of 0 to 1100 NTU and provides direct digital readout with a resolution of 0.01 NTU for the lowest range.

The optics feature a tungsten bulb light source with a life expectancy of 800 hours. The light is detected by a silicon photo diode.

The 2020 is supplied with a 9 volt alkaline battery and an AC power adapter. A fresh battery should be installed at all times, even when using the power adapter. This will ensure that the meter will power down properly.

A RS-232 serial port on the back of the meter allows an interface of the turbidimeter with an IBM compatible computer for real time data acquisition and data storage using the PC. This port also allows an interface with a RS-232 serial printer.

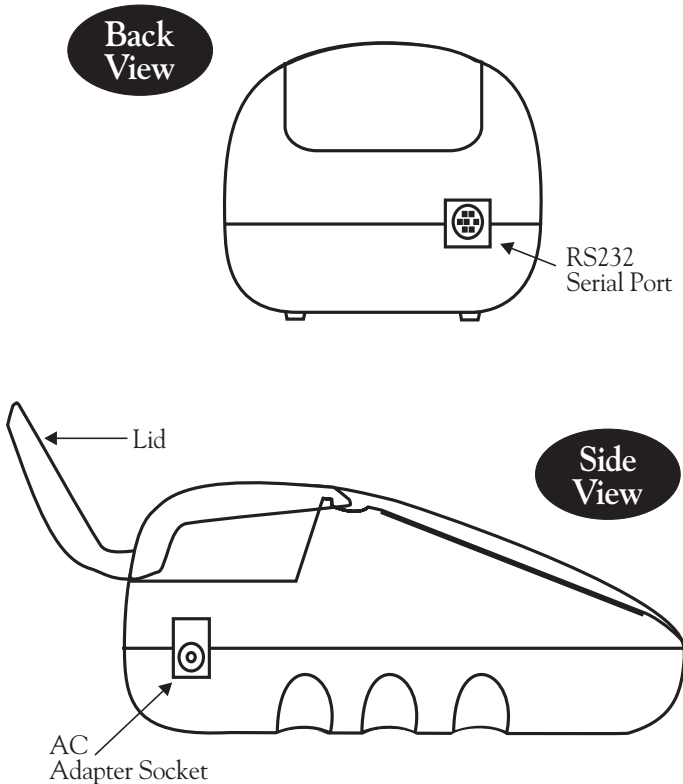

**Top  
View**

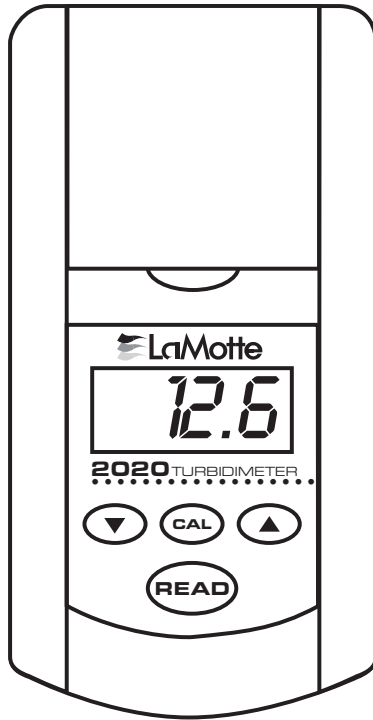

**Bottom  
View**

Serial Number

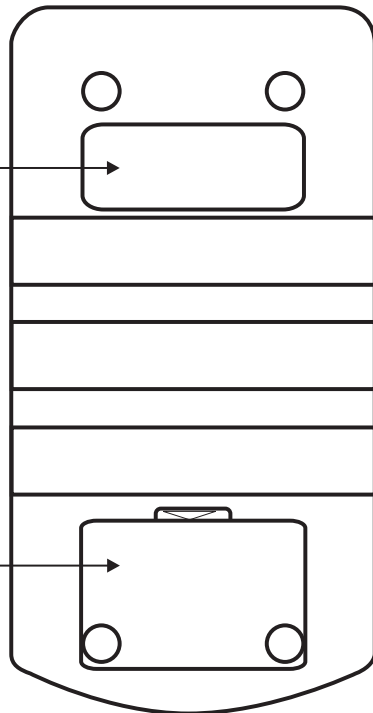

Battery Compartment

# THE KEYPAD

The DISPLAY will display turbidity reading with the following resolution:  
0.00 - 10.99 NTU; 11.0 - 109.9 NTU; 110 - 1100 NTU

- When the **READ** button is first pushed, a number will be briefly displayed that indicates the software version number.
- A walking dash “-” will be displayed when measurement is taking place.
- The display will flash after the **CAL** button has been pushed during the calibration procedure until the **CAL** button has been pushed again to enter the adjusted value.
- “OFF” will be displayed after the **READ** button has been held down for 1 second. The meter will turn off when the button is released.
- “ER1” will be displayed when the battery voltage is very low.
- “ER2” will be displayed when measured turbidity is over range (1100 NTU).
- “ER3” will be displayed when the bulb has burned out or the tube is misaligned.
- “BAT” will be displayed when the battery voltage is getting low. Readings are reliable. The meter should not be operated if the battery low indicator has appeared. Replace battery as soon as possible.
- “▲” will be displayed when the meter is in EPA mode.

See  
TROUBLE  
SHOOTING  
GUIDE  
page 23

The DOWN ARROW will DECREASE the numerical value of the display while in calibration mode.

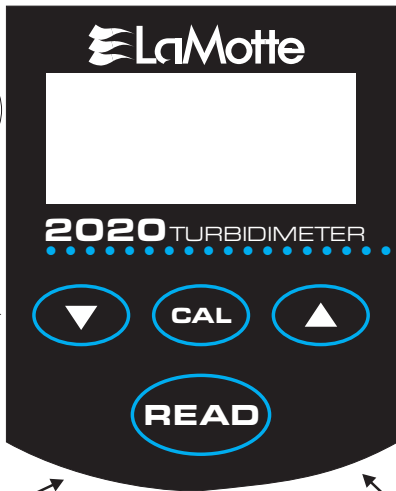

The UP ARROW will INCREASE the numerical value of the display while in calibration mode.

The READ button is used to turn the meter ON and to take readings. Pressing the button for 1 second will cause the meter to display OFF. Releasing the button when OFF is displayed turns the meter OFF.

The CAL button is used for CALIBRATION procedures and to change between standard operating mode and EPA mode.

## TURBIDITY TUBES

---

Turbidity tubes should always be washed prior to use. Use a mild detergent to remove any dirt or finger prints. Dry the outside of the turbidity tubes with a clean, lint-free cloth or disposable wipe. Allow the turbidity tubes to air-dry in an inverted position to prevent dust from entering the tube.

The handling of the turbidity tubes is of utmost importance. Scratches, fingerprints and water droplets on the turbidity tube or inside the light chamber can cause stray light interference leading to inaccurate results. It is imperative that the turbidity tubes and light chamber be clean and dry. Scratches and abrasions will permanently affect the accuracy of the readings. The inside of the tubes can be acid washed periodically and coated with special silicon oil to mask imperfections in the glass. Avoid acid contact with the black ink on the outside of the tubes. After a tube has been filled and capped, it should be held by the cap and the outside surface should be wiped with a clean, lint-free absorbent cloth until it is dry and smudge-free. Handling the tube only by the cap will avoid problems from fingerprints. Always set the clean tube aside on a clean surface that will not contaminate the tube.

Variability in the geometry and quality of the glassware is the predominate cause of variability in results. The special anti-reflective area on the 2020 tubes allows more accurate turbidity readings for low NTU samples. Only 2020 tubes should be used with the 2020 turbidimeter. Orientation of the tube in the chamber will greatly affect the test results. To obtain the most accurate results, the tubes must be positioned so that the arrow-shaped index mark molded into the housing in front of the light chamber. This will ensure that the most accurate results are obtained.

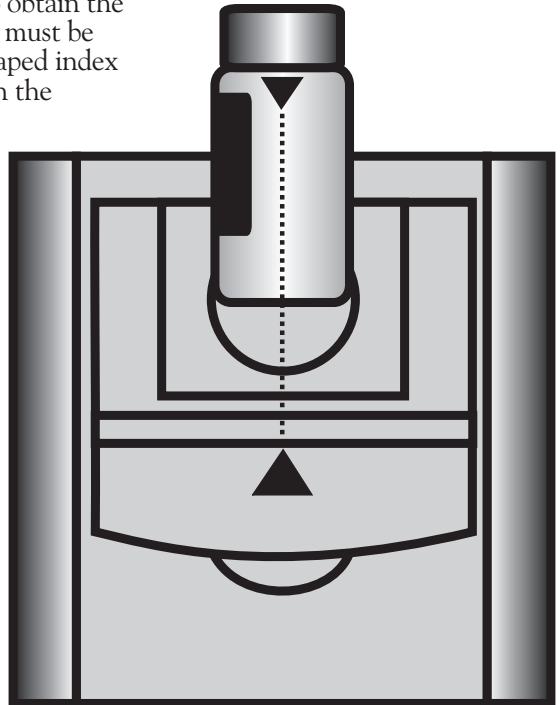

The turbidity tubes are optically selected but very small variations in the tubes may cause different readings on the same sample in low turbidity water. If greater accuracy is required, such as for drinking water requirements, the tubes supplied with the 2020 should be individually calibrated. This procedure is important for reading below 10 NTU but is not needed for samples above 10 NTU.

**1.** Fill each tube (0286) with high-quality water. (Generally distilled water or drinking water is sufficient.)

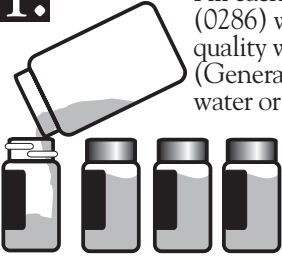

**2.** Record a turbidity reading for each tube following the instructions for turbidity measurement on page 19.

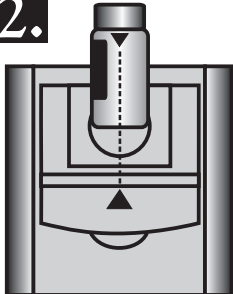

**3.** Mark the tube with the lowest reading with an "R", for reference turbidity tube, near the top of the tube with a permanent marker.



**4.** Follow the Calibration Procedure on page 17 using the reference turbidity tube, turbidity-free water, and the 1.00 NTU or 10.0 NTU AMCO™ standard.

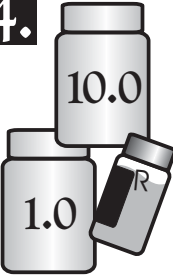

**5.** Fill the remaining turbidity tubes with the same AMCO™ turbidity standard as in the reference turbidity tube.

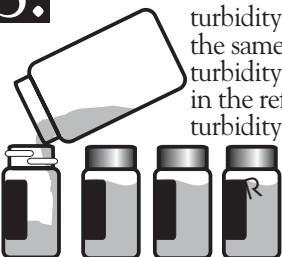

**6.** Insert each tube into the meter with the proper orientation, Close lid and record the reading for each tube.

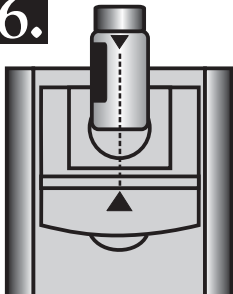

**7.** The difference between the theoretical value (1.00 NTU or 10.0 NTU) and the actual value is the correction factor for that tube. This factor should be used when comparing results from different tubes.

# CALIBRATION

---

## STANDARD SOLUTIONS

---

The 2020 has been pre-calibrated in the range of 0 to 1100 NTU with AMCO™ primary standards manufactured by Advanced Polymer Systems, Inc. This allows the 2020 to be used for treated water, natural water or wastewater. Recalibration of the 2020 by the user is not required. However, a procedure to standardize the calibration should be performed to obtain the most accurate readings over a narrow range.

Two AMCO™ standards of 1.00 NTU and 10.0 NTU are supplied with the 2020. Standards of other values are available as accessories. The standards are a suspension of uniformly sized plastic “micro spheres” in ultra pure water, which require no preparation and are stable for long periods of time. These standards were manufactured specifically as a reference to calibrate the 2020. Only LaMotte specific AMCO™ standards should be used with the 2020. These standards are guaranteed to be accurate to within  $\pm 1\%$ , if the following precautions are observed:

- The standards will remain stable for up to one year after the fill date.
- Never pour any unused or used standard back into the primary standard bottle.
- Do not open the bottle in a dusty or dirty environment. Dust and contaminants from the air can ruin the quality of the standard solutions.
- Before filling a tube with a standard, rinse the inside of the tube with a small amount of standard.
- Cap the standard bottle and the tube immediately after filling.

With proper preparation techniques, freshly prepared Formazin standards should be equivalent to the AMCO™ standards and can be used for meter calibration. A 4000 NTU Formazin Standard is available from LaMotte Company for use in preparing calibration standards. (See “Optional Accessories,” pg. 6.) Correct procedures and approved methods for the use of Formazin standards can be found in the current edition of Standard Methods for Examination of Water and Wastewater.

Note: Change battery when ERI (very low battery) is displayed. Operating the meter with a very low battery could result in permanently erasing the calibration.



## CALIBRATION PROCEDURE

1.

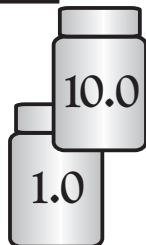

Select a LaMotte AMCO™ 2020 Standard in the range of the samples to be tested. NOTE: Only use LaMotte AMCO™ Standards specific to the 2020 Turbidimeter. Contact LaMotte for replacement standards.

2.

Fill a turbidity tube with the standard, cap, and wipe the tube clean with a lint-free cloth.

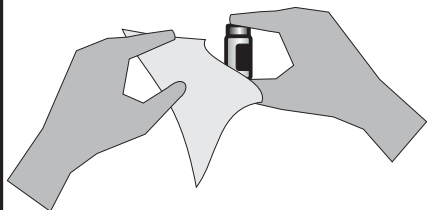

3.

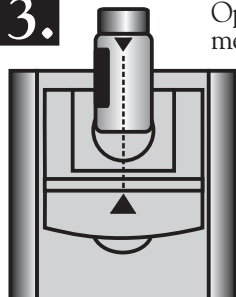

Open the lid of the meter. Align the indexing arrow mark on the tube with the indexing arrow mark on the meter, and insert the tube into the chamber.

4.

Close the lid. Push the **READ** button. If the displayed value is

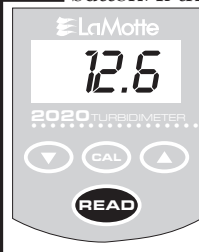

not the same as the value of the reacted standard (within the specification limits), continue with the calibration procedure.

5.

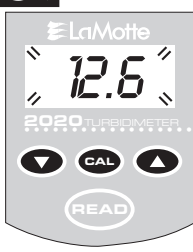

Push the **CAL** button for 5 seconds until **CAL** is displayed. Release button. The display will flash. Adjust the display with the ▼ and ▲ buttons until the value of the standard is displayed.

6.



Push the **CAL** button again to memorize the calibration. The 2020 display will stop flashing. Calibration is complete.

7.

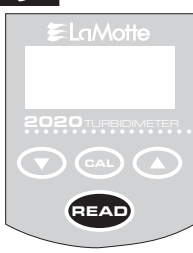

Turn the unit off by holding the **READ** button down for at least 1 second, or proceed to measure the test samples following the procedure on page 19.

## Note

The calibration procedure should be followed once a week, or more often as required by regulations and laws for compliance monitoring. The calibration of the meter is independent of the operating mode.

# ANALYSIS PROCEDURES

## SELECTING THE EPA MODE

The 2020 turbidity meter has two operating modes, the standard operating mode and the EPA mode. The meter can only be switched from one mode to the other while turning the 2020 on, from the OFF state. The 2020 will remain in which ever mode it was last used, even if the meter has been turned OFF.

To switch from one mode to the other mode:

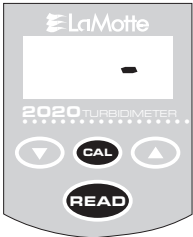
<p><b>1.</b></p>  <p>Turn OFF the 2020, if it is on.</p>	<p><b>2.</b></p>  <p>Press <b>CAL</b> button and hold it down while pressing the <b>READ</b> button to turn the meter on.</p>
---	--

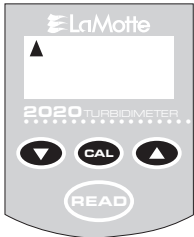

The meter will come on in the opposite mode than it was in previously. (While in EPA mode the ▲ will be visible on the display).

The standard operating mode displays the measured turbidity to the full resolution of the meter. The EPA mode displays the measured turbidity rounded to the reporting requirements of the EPA and Standard Methods compliance monitoring programs. This greatly simplifies the reporting requirements by eliminating the need for the user to manually round off the results according to EPA specifications. The EPA requires these reporting requirements because it recognizes the inherent accuracy of turbidity measurements within the specified ranges.

Note: The calibration of the meter is independent of the operating mode.

# TURBIDITY MEASUREMENT

1.



Fill a clean container with at least 50 mL of sample water and cover. Set sample aside to allow sample to equilibrate to air temperature and let gases escape. Avoid contaminants. Analyze as soon as possible.

2.

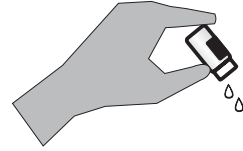

Rinse an empty turbidity tube with a portion of the sample. Shake out excess water.

3.

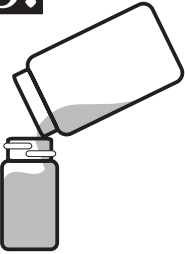

Fill the turbidity tube (0286) to the neck by carefully pouring the sample down the side of the tube to avoid creating bubbles.

4.

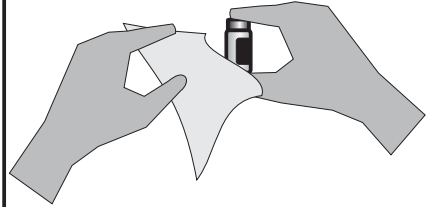

Cap the tube and wipe tube dry with a clean lint-free tissue.

5.

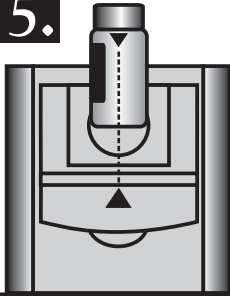

Open the 2020 lid. Align the indexing arrow on the tube with the indexing arrow on the meter. Insert the turbidity tube into chamber.

6.



Close the lid. Push the **READ** button. The turbidity in NTU units will be displayed within 5 seconds.

7.

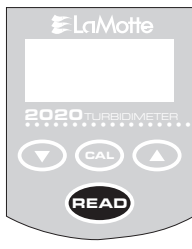

The 2020 will turn off automatically 2 minutes after the last button push. To turn the meter OFF manually, hold the **READ** button down for at least 1 second. Release the button when OFF is displayed.

## Note

If the sample is higher than 1100 NTU, it must be diluted and retested. See pages 20-22.

## **PREPARATION OF TURBIDITY FREE WATER**

---

An accessory package (Code 1800, not included) is available for preparing turbidity free water for dilution of high turbidity samples.

The preparation of turbidity free water requires careful technique. Introduction of any foreign matter will affect the turbidity reading. A filtering device with a special membrane filter is used to prepare turbidity-free water. The filter, filter holder, and syringe must be conditioned by forcing at least two syringes full of deionized water through the filtering apparatus to remove foreign matter. The first and second rinses should be discarded. Turbidity-free water as prepared below may be stored in the dark at room temperature in a clean glass bottle with a screw cap and used as required. The storage container should be rinsed thoroughly with filtered deionized water before filling. The water should be periodically inspected for foreign matter in bright light.

See procedure on next page...

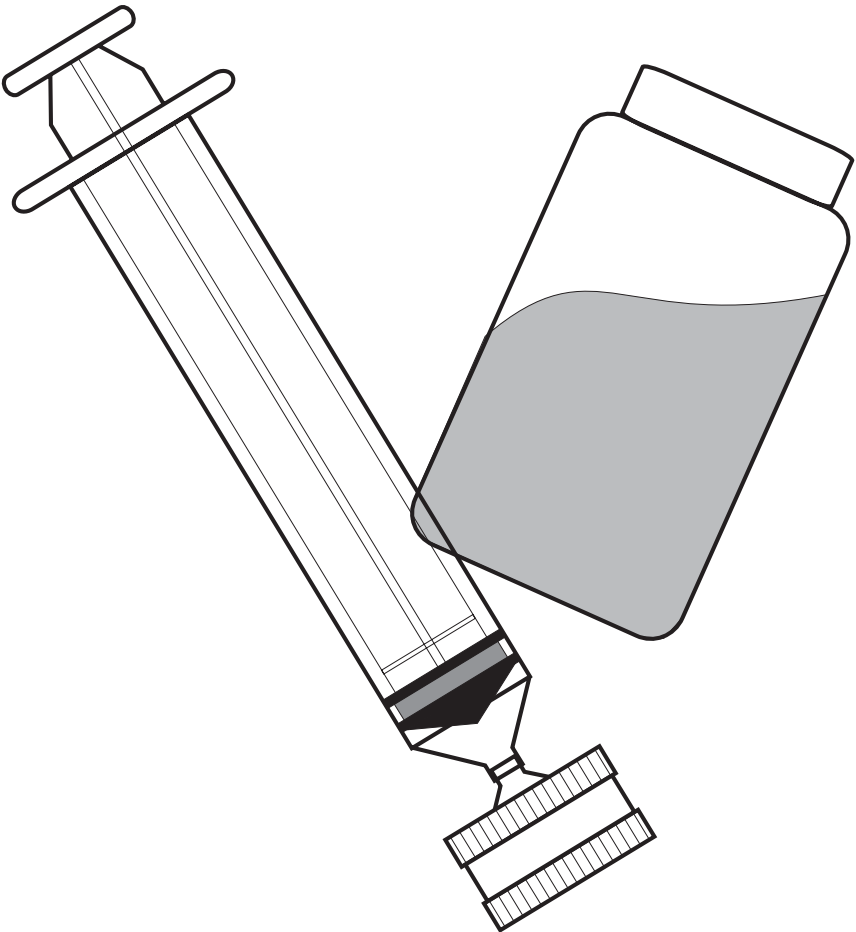

## PROCEDURE:

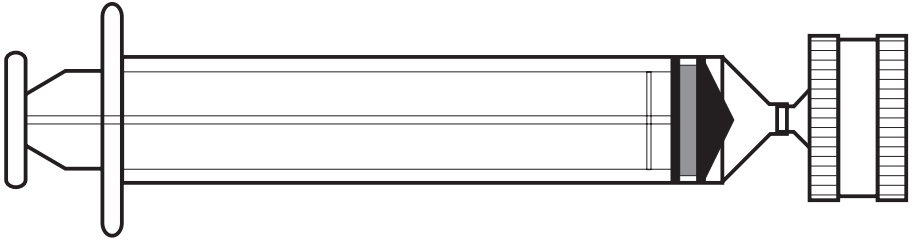

1.

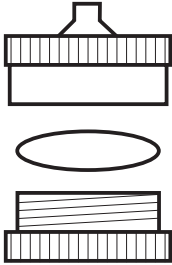

Unscrew the top of the filter holder (0598). (The black O-Ring should remain in the top part of the filter holder). Place a white membrane filter (1103) on the screen inside. Position the filter disk so that it covers the entire surface of the screen. Replace the top of the filter holder and screw on securely. Note: the membrane filters are white and packaged between two blue protective disks. Handle membrane filters with extreme care.

2.



Remove the plunger from the syringe (0943). Attach filter holder to the bottom of the syringe.

3.

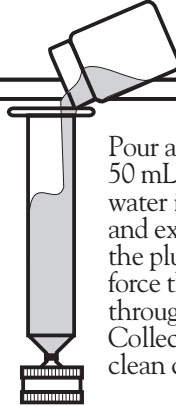

Pour approximately 50 mL of deionized water into the barrel and exert pressure on the plunger to slowly force the water through the filter. Collect water in a clean container.

4.

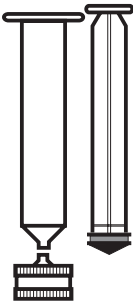

Remove the filter holder from the syringe, then remove the plunger from the barrel. (This step is required to prevent rupturing the membrane filter by the vacuum as the plunger is removed.)

5.



Replace the filter holder and repeat steps 3 and 4 until the desired amount of turbidity-free water has been collected.

Periodically examine the membrane filter to insure that no holes or cracks are present. Depending on the nature of the unfiltered water, it is possible to prepare a liter or more of turbidity-free water using a single filter. The membrane filter may be stored in the holder indefinitely and used as required.

## **DILUTION PROCEDURES**

---

If a sample is encountered that is higher than 1100 NTU, a careful dilution will bring the sample into the acceptable range. However, there is no guarantee that halving the concentration will exactly halve the NTU values. The particulates often react in an unpredictable manner when diluted.

## **TESTING TIPS**

---

1. Samples should be collected in a clean glass or polyethylene container.
2. Samples should be analyzed as soon as possible after collection.
3. Discard tubes that are badly scratched.
4. Gently mix sample by inverting before taking a reading but avoid introducing air bubbles.
5. Turbidity readings will be affected by electric fields around motors.
6. Carbon in the sample will absorb light and cause low readings.
7. Observe shelf life recommendations for turbidity standards.
8. The turbidimeter should be placed on a surface free from vibration. Vibrations can cause high readings.
9. Excessive color in a sample will absorb light and cause high readings. The user should verify if a certain level of color will cause a significant error at the level of turbidity being tested.

## TROUBLESHOOTING

PROBLEM	CHECK	ACTION
No Power	Battery	Replace
	AC Adapter	Plug in
	AC Wall Outlet	Verify power source
	Contact LaMotte for Return Authorization	Return to LaMotte for repair
Suspect Calibration	Check calibration with standards	Use new standards
	Verify standards with Formazin	Run alternate test with Formazin
	Verify with another meter	Check other meter calibrations
	Check tube alignment	Re-align tube
	Check sample tubes for dirt and scratches	Check, clean and/or replace if necessary
	Check to see if internal meter components are wet	Always dry tubes before inserting. Examine chamber for visible moisture.
	Reset meter to factory calibration	With meter off, hold down ▼ and press <b>READ</b>
	Battery	A fresh battery should be installed at all times, even when using the power adapter. This will ensure that the meter will power down properly and the calibration will not be lost. Return meter for recalibration.
	Contact LaMotte for Return Authorization	Return for calibration check
<i>ER1</i>	Very low battery	Change battery immediately (see pg. 16)
<i>ER2</i>	Over range	Dilute sample
<i>ER3</i>	Burnt out bulb or misaligned tube	Check alignment Call LaMotte
<i>BAT</i>	Low Battery	Change battery

## RS232 PORT

---

The 2020 Turbidimeter may be interfaced with any IBM compatible computer using an Interface cable (Code 1772). The meter may also be interfaced with an RS-232 serial printer, using an appropriate cable and setting the printer configuration to the output below.

Output: RS232 compatible, asynchronous serial, 9600 baud, no parity, 8 data bits, 1 stop bit.

Computer Connection: RS232 interface connection, 8 pin mDIN/9 pin F D-submin.

Pin out:

5	RS-232 TxD
3	RS-232 RxD
4, 6, 8	digital ground



## **MAINTENANCE**

---

### **REPLACING THE BATTERY**

---

The LaMotte 2020 uses a standard 9-volt alkaline battery that is available worldwide. A fresh battery should be installed at all times, even when using the power adapter. This will ensure that the meter will power down properly. The battery compartment is located on the bottom of the case. To replace the battery:

1. Open the battery compartment lid
2. Remove the battery and disconnect the battery from the polarized plug.
3. Carefully connect the new battery to the polarized plug and insert it into the compartment.
4. Close the battery compartment lid

### **REPLACING THE LAMP**

---

The tungsten lamp included with the model 2020 has a life of approximately 800 hours. If the display becomes unstable when using LaMotte AMCO™ standards, call LaMotte Company for a return authorization number to have the lamp replaced and have the unit examined.

### **REPAIRS**

---

If it is necessary to return the instrument for repair, telephone LaMotte Company at 1-800-344-3100 or fax 1-410-778-6394 for a return authorization number.







**LaMOTTE COMPANY**

Helping People Solve Analytical Challenges®

PO Box 329 • Chestertown • Maryland • 21620 • USA  
800-344-3100 • 410-778-3100 (Outside U.S.A.) • Fax 410-778-6394  
Visit us on the web at [www.lamotte.com](http://www.lamotte.com)